

HOIST RING SAFETY INFORMATION

Do's & Don'ts of Installing & Using Hoist Rings

DO:

- **ALWAYS READ SAFETY PRECAUTION PAGE PRIOR TO USE OR INSTALLATION.**
- **ALWAYS INSPECT THE HOIST RING BEFORE EACH USE.**
- Regularly inspect all hoist ring parts.
- Always tighten the screw to the recommended torque value.
- Always make sure that the hoist ring is free to pivot and swivel in all directions.
- Always choose a hoist ring with the proper load rating. See the "Actual Load" equation on the back page to help you choose the appropriate hoist ring.
- Always make sure that the bushing of the hoist ring sits flush against the object being lifted.
- Install hoist rings in materials that have a tensile strength of at least 80,000 psi.
- Always make sure the thread engagement is at least 1.5 times the diameter of the hoist ring screw.
- When installing a hoist ring in a through-hole with a nut and washer, make sure to use a Grade 8 nut that has full thread engagement.
- Consider periodic load-testing as an extra precaution.

DON'T:

- **NEVER EXCEED RATED LOAD.**
- **NEVER APPLY SHOCK LOAD.**
- Never use a hoist ring that you believe is damaged.
- Never use a hoist ring that has damaged threads on the screw.
- Never use a hoist ring in an application where it does not pivot and swivel in every direction freely.
- Never use a hoist ring that is not tightened to the recommended torque.
- Never replace the components of the hoist ring with anything other than parts recommended by Actek.
- Never use a hook larger than the diameter of the hoist ring opening.
- Never shim or use washers between the hoist ring and surface of object being lifted.

Hoist Ring Inspection & Maintenance

ALWAYS INSPECT THE HOIST RING BEFORE EACH USE. MAKE SURE:

- The screw is tightened to the recommended torque.
 - If the screw is not tightened, the threads may be stripped on a vertical lift.
- The bushing of the hoist ring sits flush against the object being lifted.
 - This ensures that the recommended torque puts the proper preload onto the hoist ring allowing the hoist ring to reach its full 5:1 safety factor.
- The hoist ring is free to swivel and pivot in every direction.
 - If the hoist ring binds up in any direction, it should be removed from service.
- There are no signs of corrosion.
 - This can cause deterioration to the hoist ring material allowing for fatigue or cracking to take place. Corrosion can also prevent the hoist ring from pivoting and swiveling freely.
- There are no signs of wear or cracks, especially on the screw, shoulder pins, and bail.
 - Damage or wear on the screw head, shoulder pins, or bail may be an indication that the hoist ring is coming into contact with something during use. This should be avoided as such contact can cause binding and shock loads which exceed the rating of the hoist ring.
- The shoulder pins are secure and do not rotate or come loose.
 - This can be checked by using pliers to rotate the shoulder pins by hand. If the shoulder pin does rotate, it is no longer securely in place and could come loose causing the hoist ring to break.

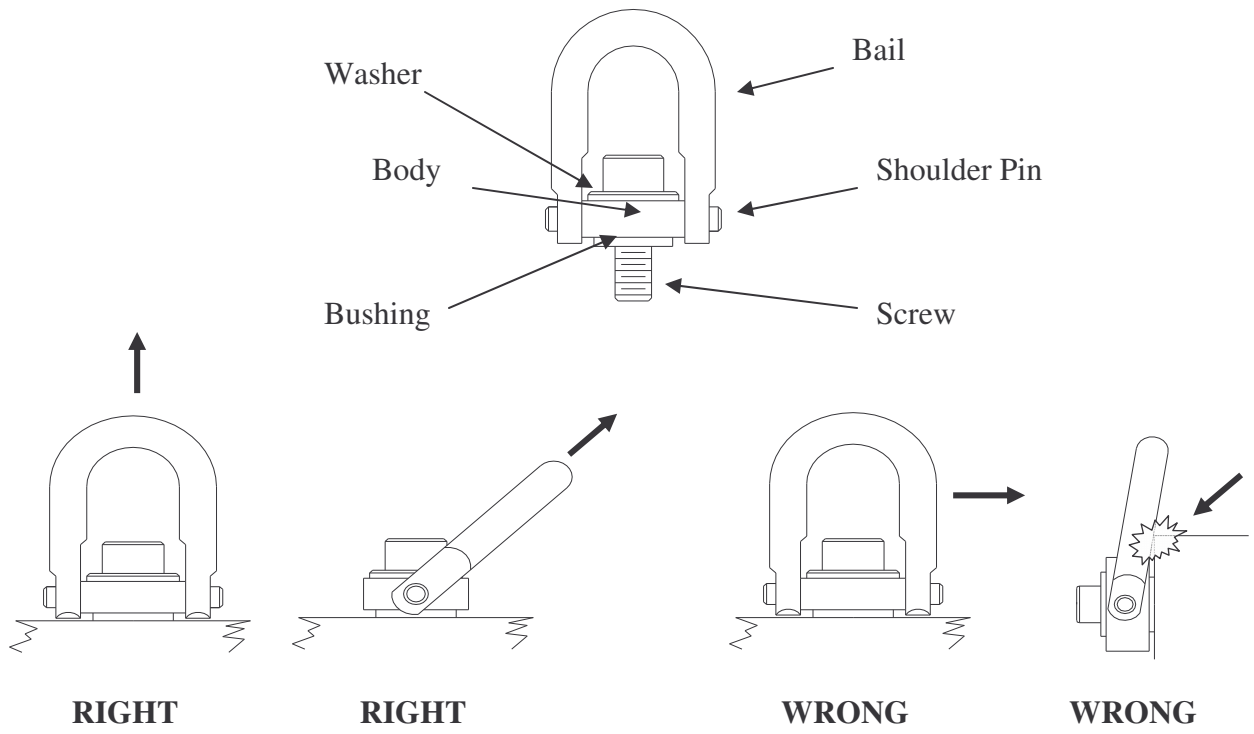

Important: The load on each hoist ring is not simply total weight divided by the number of hoist rings. The resultant force can be significantly greater at shallow lift angles and with unevenly distributed loads. See the example and chart below.

L = Load experienced by hoist ring N = Number of hoist rings = 4
 W = Total weight = 2,000 Lbs. A = Lifting angle

$$L = \frac{W}{N \sin A}$$

If A = 60:

$$L = \frac{2000}{4 \sin 60} = 577 \text{ Lbs.}$$

If A = 20:

$$L = \frac{2000}{4 \sin 20} = 1,462 \text{ Lbs.}$$

Lifting Angle (Degrees)	Number of Hoist Rings	Weight of Load (Pounds)	Actual Applied Load on Hoist Ring (Pounds)
90	4	2,000	500
80	4	2,000	510
70	4	2,000	535
60	4	2,000	580
50	4	2,000	655
40	4	2,000	780
30	4	2,000	1,000
20	4	2,000	1,465

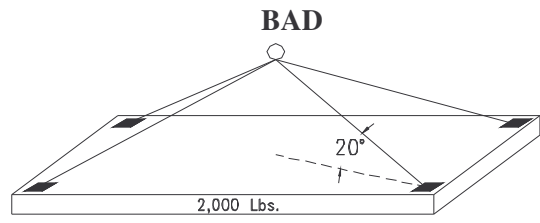
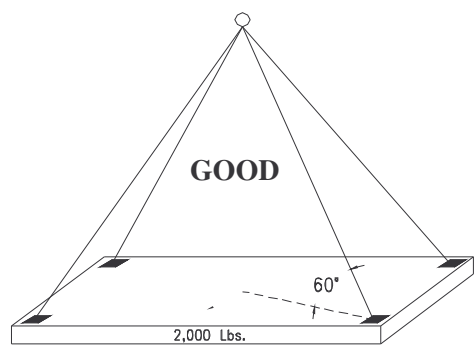

SWIVEL HOIST RINGS vs. SHOULDERED EYEBOLT

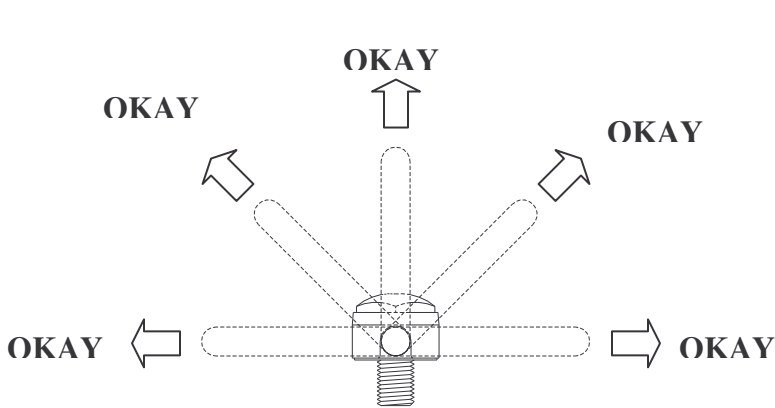

Swivel Hoist Ring
- same load rating at any angle

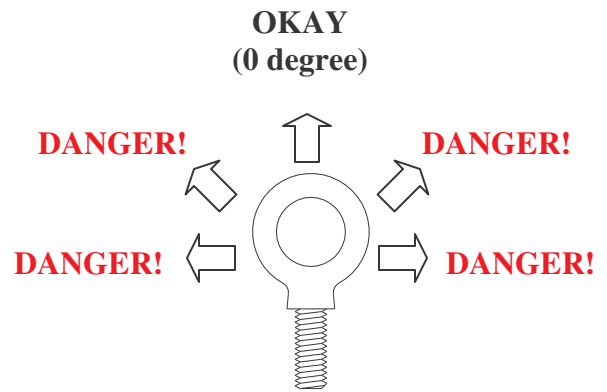

Shouldered Eyebolt
- load rating only good for zero degree

Eyebolts have been around for over 100 years and have been doing a good job when used properly. Properly, meaning the direction of the load must be at zero degree. If the load shifts or the direction of loading on the eyebolt is as much as 10 degrees off the zero line of force, the result is a bent eyebolt. **When you bend the eyebolt, it is broken!**

You can't see the break most of the time. If you examine the bent area using x-ray, you will find the damage. This will lead to failure if the eyebolt is used any longer.

Swivel Hoist Rings are designed for lifting at any angle because they can swivel 360° and pivot 180°. Therefore, the rated load remains the same, regardless of the angle of force. As a result, you **increase safety and peace of mind.**

HOIST RING PRODUCT SAFETY FACTS

WARNING: PRIOR TO USING ANY HOIST RING, PLEASE READ THE FOLLOWING FOR PROPER INSTALLATION AND USAGE.

As with all mechanical devices, regular inspection for wear and strict adherence to use instruction is necessary to prevent misuse failure.

- Despite the 5:1 safety factor, **NEVER EXCEED THE RATED LOAD CAPACITY.** This safety margin is needed in case of misuse, which could drastically lower load capacity.
- Tighten mounting screws to torque recommended. Periodically check torque because screws could loosen in extended service.
- Tensile strength of parent material should be above 80,000 PSI to achieve full load rating. For weaker material, consider through-hole mounting with a nut and washer on the other side.
- **DO NOT APPLY SHOCK LOADS.** Always lift gradually. Repeat magnaflux testing if shock loading ever occurs.
- **Make sure the hoist ring pivots and rotates in all directions freely.**
- **Rated load will be reduced based on different angles of the loading.**

Important: The load on each hoist ring is not simply total weight divided by the number of hoist rings. The resultant force can be significantly greater at shallow lift angles and with unevenly distributed loads. See the example below.

SAFTEY ENGINEERED SWIVEL HOIST RINGS

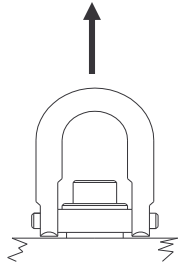

RIGHT

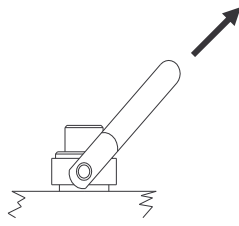

RIGHT

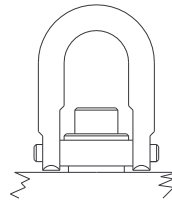

WRONG

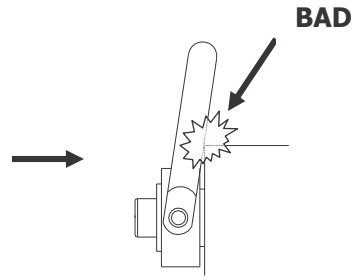

WRONG

FORGED SWIVEL HOIST RINGS

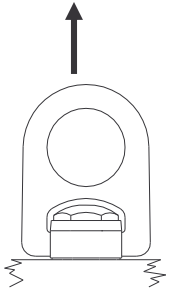

RIGHT

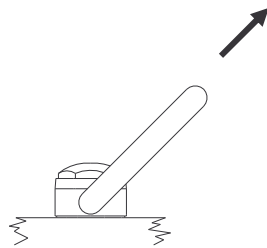

RIGHT

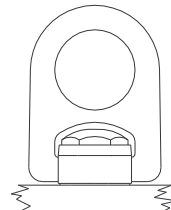

WRONG

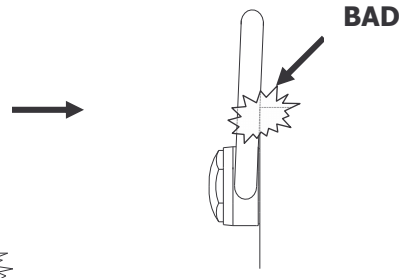

WRONG

STAINLESS STEEL SWIVEL HOIST RINGS

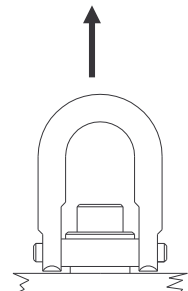

RIGHT

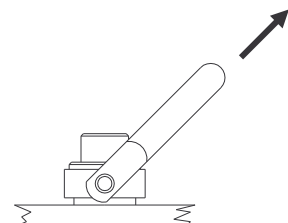

RIGHT

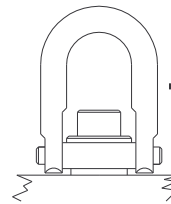

WRONG

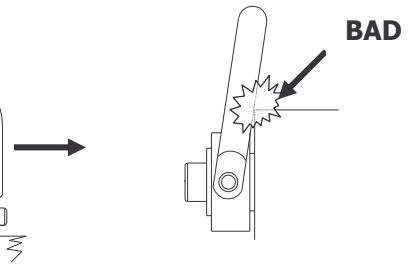

WRONG

SIDE LOAD HOIST RINGS

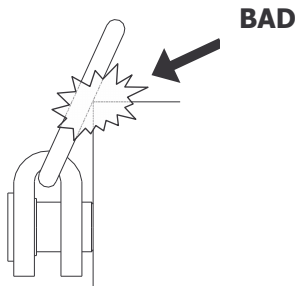

100% of Rated

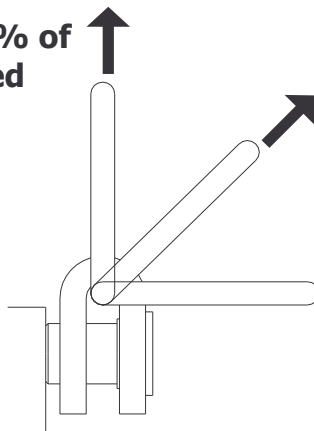

80% of Rated

75% of Rated

LIFTING RING HOIST RINGS

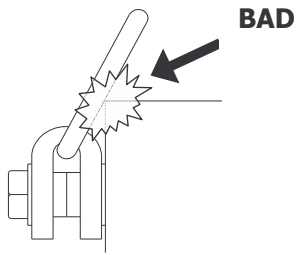

**100% of
Rated Load**

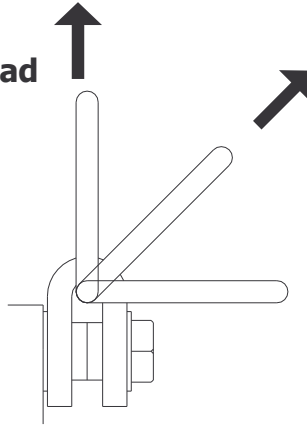

**80% of
Rated Load**

**75% of
Rated Load**

SIDE PULL HOIST RING

RIGHT

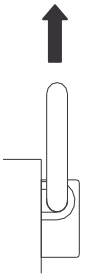

WRONG

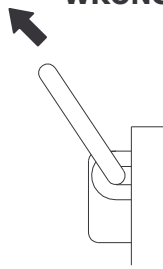

BAD

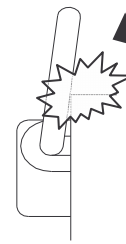

FORGED HOIST RING

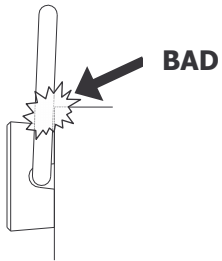

LARGE OPENING HOIST RING

RIGHT

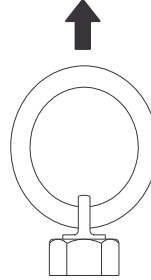

WRONG

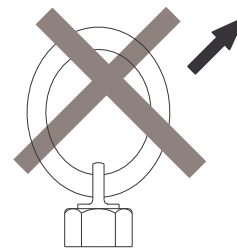

ROUND BASE SWIVEL & PIVOT HOIST RING

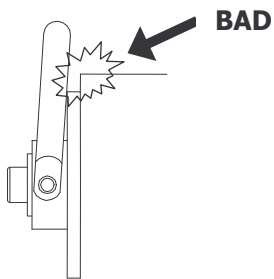

PIVOT LIFTING PLATE

RIGHT

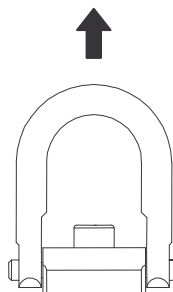

WRONG

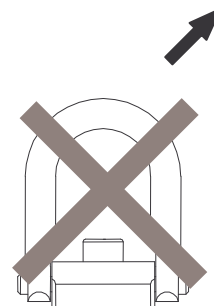

STREET PLATE LIFTING RING

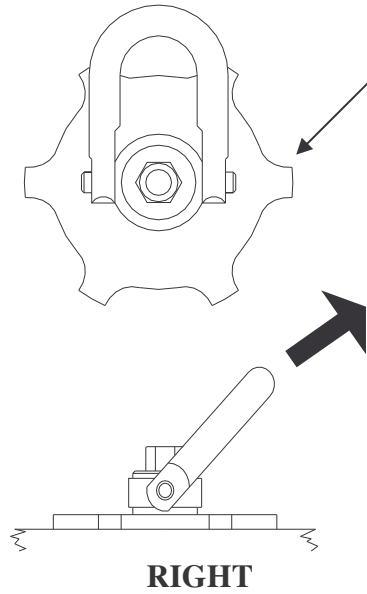
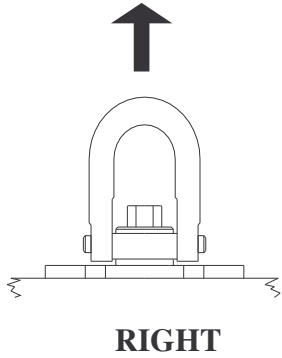

Lugs for
installing and

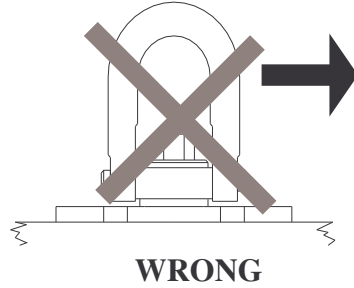

WELDING INSTRUCTION

- Nut plate should have 1/8" clearance to trench plate.
- It is allowed to replace an old nut if all previous weld metal is removed.
- Use jig to make sure threaded plate is flush and square with top surface of trench plate.
- Preheat plate to 450°-700°F.
- Weld using Lincoln Jet Weld #ED010558 LH 70 - E7018 or 7024 - 3/16 dia. rod or equivalent
- Back-gouge root to sound metal.
- Weld second side.
- Grind weld on top surface flush.
- Allow slow cooling.

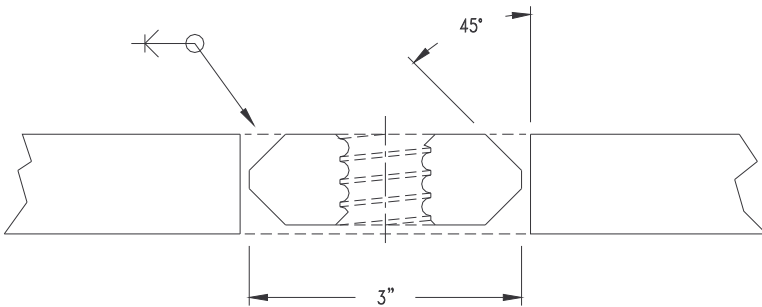

***NOTE:** After the nut has been welded to the plate, surfaces of the weld must be ground to the same surface level as the trench plate. This procedure allows the hoist ring to sit flush against the trench plate surface. Not doing so will cause the hoist ring not to sit properly and will lead to usage failure.

MATERIAL

- Threaded insert plate made from AISI 4140 steel, quench and tempered to Hardness Rockwell C 28-34.
- Insert plate shall have minimum 1" thickness.
- Shape can be square or round, 3" diameter.

LIFTING DEVICE **SAFETY INFORMATION**

TE-CO Hoist Rings are intended for use only by trained, qualified and experienced workmen. Misuse of any TE-CO Hoist Rings or lack of supervision and inspection can lead to serious accidents including death. TE-CO has always stressed that safety is of utmost importance.

Prior to any use of TE-CO Hoist Rings, evaluation of the product application, safety precautions, safe working load, and control of all field conditions is mandatory. Prevent applications that exceed the safe working load or any other product misuse. TE-CO cautions you that all safety factors shown are approximate. Safe working loads should never be exceeded under any circumstances.

If you have any questions about the proper use or installation of any TE-CO Hoist Ring, please contact our office directly.

109 Quinter Farm Road, Union, OH 45322 • (800) 543-4071

Safety Notes

TE-CO ensures that all materials used on all our Hoist Ring products meet or exceed the safety requirements for lifting. The safe working loads listed are based upon a new or in "as new" condition product. A safe working load is considered to be the greatest load that should be applied to an item at any time.

Inspection & Maintenance

In order to insure the safest lifting, all for safety purposes, TE-CO Hoist Rings must be properly used and maintained in the proper manner. Hoist rings may be are subject to wear, corrosion, deformation, overloading, and other limiting factors which may will affect the safe working load. Prior to use the user of any TE-CO Hoist Rings, the product should be regularly inspected to determine if it may be used or whether it should removed from service. It is the responsibility of the user to inspect all lifting units for signs of wear and to discard the any parts when showing visible signs of wear. Every user should establish a safety inspection program for routine visual inspection of all products to determine whether signs of wear (e.g. cracks, corrosion, deformation) are present. The product inspection schedule should be established based upon factors such as frequency of use, period of use and environment. In addition to the regular safety inspection, the following safety directives must be followed:

- Prior to use, always inspect hoist rings for possible wear or damage.
- Never use hoist rings that show any sign of wear or damage.
- Never use hoist rings if bail is bent or elongated.
- Prior to use, threads must be clean, undamaged, and must fit properly.
- Always install hoist rings using the listed torque value. Periodically check torque because screws could loosen during extended service.
- Bent bolts should be discarded or replaced never straightened; failing to do so may lead to serious injuries or death.
- Never use washers or any spacers between bushing and mounting surface.
- Always make sure the hoist ring pivots and rotates in all directions freely.
- Never use hoist ring near or around corrosive material.
- If hoist ring is exposed to extreme temperatures (hot or cold), please contact our engineering department for suggestions/consultation.
- Safe working loads should never be exceeded under any circumstances.