









Spring Loaded Devices

Ball Plungers	2	
Metric Ball Plungers	2	
Delrin® Body Ball Plungers.....	3	
Press Fit Ball Plungers.....	3	
Press Fit Ball Plungers No Flange.....	4	
Press Fit Spring Plungers.....	4	
Spring & Ball Plunger Wrenches	4	
Ball Buttons	4	
Standard Spring Plungers		
• Heavy End Force	5	
• Light End Force.....	6	
Short Spring Plungers		
• Heavy End Force	7	
• Light End Force.....	8	
Shortie Spring Plungers	9	
Metric Spring Plungers	9	
Posi Hex Steel Plungers	10	
Flat Hex Nose Plungers	11	

Long Travel Hex Nose Plungers	11	
Hex Nose Plungers.....	11	
Delrin® Knob Steel Hand Retractable Spring Plungers	12	
Delrin® Knob Stainless Steel Hand Retractable Spring Plungers	13	
Knurled Knob Hand Retractable Spring Plungers – Steel & Stainless Steel	14	
Hex Drive Knob Retractable	15	
T-Handle Retractable Plunger	15	
Hand Retractable Spring Plungers - Quick Release "Pull Ring"	15	
Stubby Hand Retractable Spring Plungers -Quick Release "Pull Ring"	16	
Lever Type Plungers: Locking	16	
Lever Type Plungers: Non-Locking	17	
Lever Type Stubby Steel Plungers	17-18	
Spring Stops.....	18	
Information/Inch Tap Drill Sizes Table for Spring Plungers	19	
Special Plunger Quotation Request.....	20	

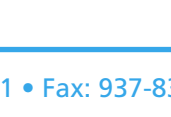

SPRING LOADED DEVICES

Ball Plungers

- Material:
 - Steel Body: 12L14 Steel
 - Stainless Steel Body: 303 Stainless Steel
 - Ball: 440 Stainless Steel or Nylon
- Smallest and lightest spring loaded device
- Side-load tolerant
- Controlled end forces
- Screwdriver installation
- Many sizes conform to TCMAI standards
- Bodies are color coded to indicate end forces:
 - Plain or Zinc = Light Force
 - Black = Standard Force
 - Gold = Heavy Force

NYLON THREAD LOCKING ELEMENT IS STANDARD ON ALL SIZES
To order ball plungers without a locking element, simply add an "X" to the end of the part number (ex. 52821X). Pricing is the same with or without locking element.

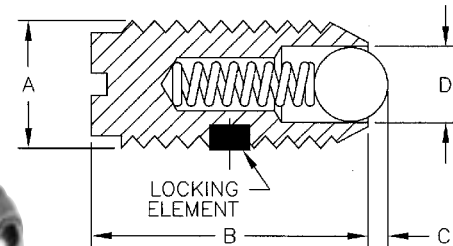

STEEL BODY			STAINLESS STEEL BODY			End Force (lbs)		Thread			Ball Dia. D	Weight (lbs/100pcs)
Stainless Steel Ball Part No.	Nylon Ball Part No.	Body Color Type	Stainless Steel Ball Part No.	Nylon Ball Part No.	Body Color Type	Initial	Final	A	B	C		
52821	53821	Black	52901	53830	Plain	.12	.50	4-48	3/16	.020	.062	.005
52822	53822	Black	52902	53831	Plain	.25	.75	5-40	1/4	.020	.062	.02
52823	53823	Black	52903	53832	Plain	.50	1.00	6-40	5/16	.023	.078	.02
52824	53824	Black	52904	53833	Plain	.50	1.25	8-36	11/32	.025	.093	.04
52825	53825	Black	52923	53852	Plain	.50	1.25	8-32	11/32	.025	.093	.04
52801	53801	Zinc	52905	53834	Plain	.50	1.50	10-32	33/64	.025	.093	.30
52802	53802	Black	52906	53835	Black	1.50	3.00	10-32	33/64	.025	.093	.30
52803	53803	Gold	52907	53836	Gold	2.00	5.00	10-32	33/64	.025	.093	.30
52804	53804	Zinc	52908	53837	Plain	2.00	4.00	1/4-20	17/32	.035	.125	.40
52805	53805	Black	52909	53838	Black	3.00	7.00	1/4-20	17/32	.035	.125	.40
52806	53806	Gold	52910	53839	Gold	4.00	12.00	1/4-20	17/32	.035	.125	.40
52807	53807	Zinc	52911	53840	Plain	2.00	4.50	5/16-18	37/64	.040	.156	.70
52808	53808	Black	52912	53841	Black	4.00	9.00	5/16-18	37/64	.040	.156	.70
52809	53809	Gold	52913	53842	Gold	6.00	17.00	5/16-18	37/64	.040	.156	.70
52810	53810	Zinc	52914	53843	Plain	2.50	5.00	3/8-16	5/8	.048	.187	1.20
52811	53811	Black	52915	53844	Black	5.00	10.00	3/8-16	5/8	.048	.187	1.20
52812	53812	Gold	52916	53845	Gold	6.00	21.00	3/8-16	5/8	.048	.187	1.20
52813	53813	Zinc	52917	53846	Plain	3.00	6.00	1/2-13	3/4	.072	.281	2.60
52814	53814	Black	52918	53847	Black	6.00	12.00	1/2-13	3/4	.072	.281	2.60
52815	53815	Gold	52919	53848	Gold	6.00	30.00	1/2-13	3/4	.072	.281	2.60
52816	53816	Zinc	52920	53849	Plain	4.50	9.00	5/8-11	63/64	.096	.375	5.00
52817	53817	Black	52921	53850	Black	9.00	18.00	5/8-11	63/64	.096	.375	5.00
52818	53818	Gold	52922	53851	Gold	7.00	50.00	5/8-11	63/64	.096	.375	5.00

For information concerning installation, see page 111.

Special sizes quoted upon request – see quotation sheet on page 112.

Metric

STEEL BODY			STAINLESS STEEL BODY			End Force (lbs)		Thread A	Ball Dia. B	C	D
Stainless Steel Ball Part No.	Nylon Ball Part No.	Body Color Type	Stainless Steel Ball Part No.	Nylon Ball Part No.	Body Color Type	Initial	Final	A	mm (in.)	mm (in.)	mm (in.)
63901	63961	Black	64001	64061	Black	.90	2.25	M4 x 0.7	9 (.354)	.8 (.032)	2.5 (.098)
63920	-	Black	-	-	-	.50	1.50	M5 x 0.8	13 (.518)	.6 (.023)	2.38 (.093)
63921	-	Black	-	-	-	1.50	3.00	M5 x 0.8	13 (.518)	.6 (.023)	2.38 (.093)
63922	-	Black	-	-	-	2.00	4.90	M5 x 0.8	13 (.518)	.6 (.023)	2.38 (.093)
63902	63962	Black	64002	64062	Black	2.00	2.90	M6 x 1.0	14 (.551)	1 (.039)	3.5 (.138)
63903	63963	Zinc	64003	64063	Plain	.45	1.35	M6 x 1.0	14 (.551)	1 (.039)	3.5 (.138)
63904	63964	Gold	64004	64064	Gold	6.25	8.95	M6 x 1.0	14 (.551)	1 (.039)	3.5 (.138)
63905	63965	Black	64005	64065	Black	3.35	6.70	M8 x 1.25	16 (.630)	1.5 (.059)	5 (.196)
63906	63966	Zinc	64006	64066	Plain	1.11	2.25	M8 x 1.25	16 (.630)	1.5 (.059)	5 (.196)
63907	63967	Gold	64007	64067	Gold	8.95	13.40	M8 x 1.25	16 (.630)	1.5 (.059)	5 (.196)
63908	63968	Black	64008	64068	Black	4.45	7.80	M10 x 1.5	19 (.748)	2 (.079)	6 (.236)
63909	63969	Zinc	64009	64069	Plain	1.80	3.35	M10 x 1.5	19 (.748)	2 (.079)	6 (.236)
63910	63970	Gold	64010	64070	Gold	13.40	20.00	M10 x 1.5	19 (.748)	2 (.079)	6 (.236)
63911	63971	Black	64011	64071	Black	6.70	12.25	M12 x 1.75	22 (.866)	2.5 (.098)	8 (.315)
63912	63972	Zinc	64012	64072	Plain	2.25	4.50	M12 x 1.75	22 (.866)	2.5 (.098)	8 (.315)
63913	63973	Gold	64013	64073	Gold	16.75	25.65	M12 x 1.75	22 (.866)	2.5 (.098)	8 (.315)



Delrin® Body Ball Plungers

- Durable and lightweight
- Withstands side loading
- Stainless steel spring
- Controlled end forces
- Electrical isolation
- Nylon thread locking element not included
- Bodies are color coded to indicate end forces:
 - Blue = Light Force
 - White = Heavy Force

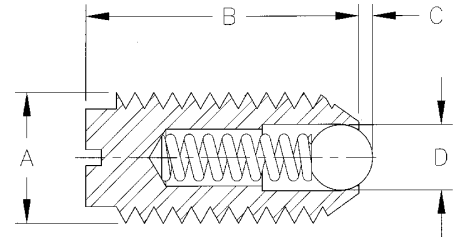

DELIRIN® BODY				End Force (lbs)*		Thread	B	C	D
Stainless Steel Ball Part No.	Nylon Ball Part No.	Body Color Type	Initial	Final	A				
57601	57650	White	2	5	1/4-20	.531	.027	.125	
57602	57651	Blue	1	2.5	1/4-20	.531	.027	.125	
57603	57652	White	4	9	5/16-18	.578	.039	.156	
57604	57653	Blue	2	4.5	5/16-18	.578	.039	.156	
57605	57654	White	5	10	3/8-16	.625	.053	.187	
57606	57655	Blue	2.5	5	3/8-16	.625	.053	.187	

*Not available with nylon thread locking element

Press Fit Ball Plungers

- Material:
 - Steel Body: 12L14 Steel
 - Stainless Steel Body: 303 Stainless Steel
 - Ball: 440 Stainless Steel
- Black Oxide Finish – Steel Only
- Ideal for installation in softer materials, such as aluminum, wood or plastic
- Sturdy shoulder provides a fixed seating position and positively resists detent force (installation hole can be counterbored to recess the shoulder)
- Use when a threaded hole would be impractical

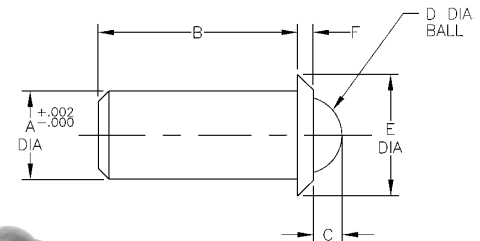

STEEL BODY		STAINLESS BODY		A	End Force (lbs)		B	C	Dia. D	Dia. E	F
Stainless Steel Ball Part No.	Nylon Ball Part No.	Stainless Steel Ball Part No.	Nylon Ball Part No.		Initial	Final					
53754	53762	53755	53780	.125	.4	1.3	.252	.035	.094	.187	.032
53756	53763	53757	53781	.125	.75	2.5	.252	.035	.094	.187	.032
53701	53764	53709	53782	.188	1.0	2.5	.410	.058	.156	.250	.035
53702	53766	53710	53784	.250	1.5	3.5	.480	.070	.188	.312	.044
53758	53768	53759	53786	.312	2.0	5.0	.643	.090	.250	.375	.045
53760	53769	53761	53787	.312	4.0	10.0	.643	.090	.250	.375	.045
53703	53770	53711	53788	.375	2.5	7.0	.790	.110	.312	.500	.078
53704	53772	53712	53790	.500	4.0	9.0	1.13	.161	.438	.688	.088
53705	53765	53713	53783	.188	2.0	5.0	.410	.058	.156	.250	.035
53706	53767	53714	53785	.250	3.0	7.0	.480	.070	.188	.312	.044
53707	53771	53715	53789	.375	5.0	14.0	.790	.110	.312	.500	.078
53708	53773	53716	53791	.500	8.0	18.0	1.13	.161	.438	.688	.088

NEW SIZES

Press Fit Ball Plungers – No Flange

- For sensitive and light duty applications
- Black thermoplastic or stainless steel body
- Stainless steel spring and ball
- Small and lightweight

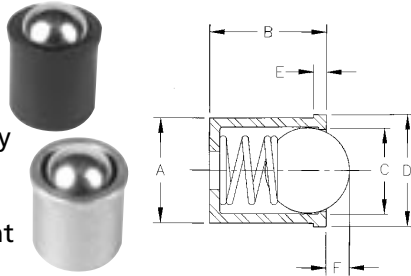

Plastic Body Part No.	Stainless Steel Part No.	End Force (lbs)*		A	B	Ball Dia. C	D	E	F
		Initial	Final						
53620	-	.67	1.57	.158	.197	.118	.181	.04	.028
-	53670	.67	1.57	.158	.197	.118	.181	.04	.032
53621	53671	.90	1.57	.197	.236	.157	.220	.04	.039
53622	53672	1.35	2.70	.235	.278	.197	.256	.04	.069
53623	53673	1.35	2.70	.315	.354	.256	.386	.04	.071

Press Fit Spring Plungers

- Material:
 - Steel Body: 12L14 Steel
 - Stainless Steel Body: 303 Stainless Steel
 - Steel Plunger: 12L14 Steel
 - Stainless Steel Plunger: 303 Stainless Steel
- Ideal for installation in softer materials such as aluminum, wood, or plastic
- Withstands high temperatures
- No thread adjustment
- Longer travel

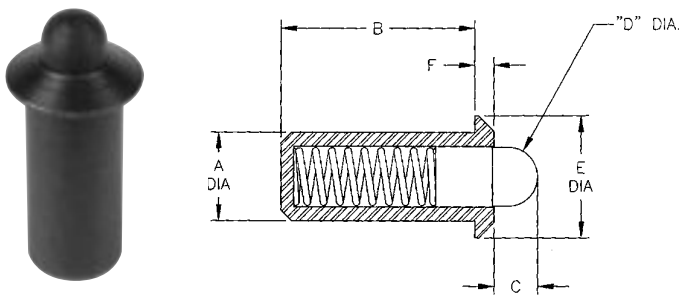

Steel Part No.	Stainless Steel Part No.	End Force (lbs)*		+.002 -.000 A	B	C	D	E	F
		Initial	Final						
53601	53650	1.50	4.50	.188	.441	.094	.121	.250	.044
53602	53651	2.50	6.00	.250	.521	.125	.168	.312	.055
53603	53652	5.00	14.00	.375	.788	.187	.234	.500	.096
53604	53653	5.00	18.00	.500	1.100	.250	.332	.688	.134
53605	53654	.75	2.00	.188	.441	.094	.121	.250	.044
53606	53655	1.25	3.00	.250	.521	.125	.168	.312	.055
53607	53656	2.50	7.00	.375	.788	.187	.234	.500	.096
53608	53657	4.00	9.00	.500	1.100	.250	.332	.688	.134

ACCESSORIES

Spring and Ball Plunger Wrenches

Designed to eliminate excessive spring compression during installation and removal of spring and ball plungers.

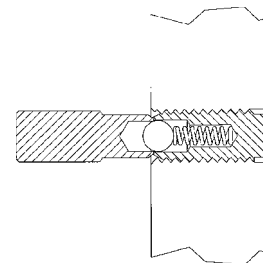

Part No.	Fits Following Spring and Ball Plunger Sizes		Weight (lbs/100pcs)
	Inches	MM	
53001	6-32	-	1
53002	8-32	M4	1
53003	10-32	M5	1
53004	1/4-20	M6	1.5
53005	5/16-18	M8	3
53006	3/8-16	M10	3
53007	1/2-13	M12	5
53008	5/8-11	-	9
53009	3/4-10	-	13
53010	1-8	-	19

Stainless Steel Ball Buttons

The ideal mating detent for ball plungers or other similar applications. Hardened and ground 440C stainless steel.

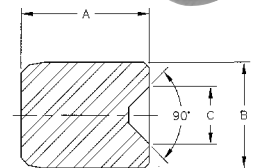
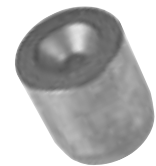

Part No.	For use with Ball Dia.	A	+.0002 -.0000	
			B	C
57501	.0620	1/8	.1075	.056
57502	.0780	1/8	.1175	.051
57503	.0938	3/16	.1614	.069
57504	.1250	1/4	.2034	.111
57505	.1560	5/16	.2559	.139
57506	.1875	3/4	.3284	.164
57507	.2813	1/2	.4378	.241
57508	.3750	5/8	.5472	.330

Standard Spring Plungers

- Carbon & Stainless Steel Bodies
- Heavy End Forces

For information concerning installation, see page 111.

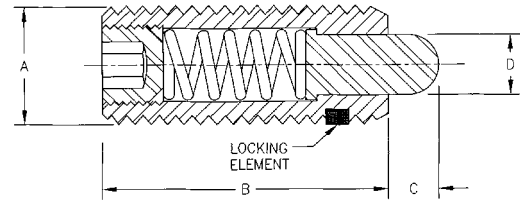

Carbon & Stainless Steel Nose

Steel Part No.	Stainless Steel Part No.	End Force (lbs)		Thread A	B	C	+.000 -.001 D	Weight (lbs/100pcs)
		Initial	Final					
52001	53201	1.50	4.50	6-32	17/32	.062	.046	.10
52002	53202	1.00	1.60	6-32	3/8	.062	.046	.10
52003	53203	2.70	7.30	8-32	5/8	.093	.070	.22
52004	53204	2.90	11.10	10-32	3/4	.125	.093	.38
52005	53205	3.00	13.00	1/4-20	1	.187	.119	.75
52006	53206	3.00	13.00	1/4-28	1	.187	.119	.75
52007	53207	2.00	9.00	1/4-20	3/4	.125	.119	.65
52008	53208	3.00	15.00	5/16-18	1	.187	.135	1.40
52009	53209	5.50	14.50	3/8-16	1-1/8	.187	.186	2.00
52010	53210	6.60	17.40	1/2-13	1-1/4	.250	.248	4.50
52011	53211	10.50	25.50	5/8-11	1-1/2	.312	.310	8.00
52012	53212	6.70	37.30	3/4-10	1-3/4	.312	.374	14.00
52013	53213	16.00	68.00	1-8	2-13/32	.500	.499	32.00

- Steel Body Plungers:
 - 12L14 Steel Body
 - Black Oxide Finish
 - Case Hardened 12L14 Steel Nose, Black Oxide Finish
- Stainless Steel Body Plungers:
 - 303 Stainless Steel Body and Nose
- Excellent wear resistance



Black Delrin® Nose

Steel Part No.	Stainless Steel Part No.	End Force (lbs)		Thread A	B	C	+.000 -.002 D	Weight (lbs/100pcs)
		Initial	Final					
52101	53220	2.70	7.30	8-32	5/8	.093	.070	.20
52102	53221	2.90	11.10	10-32	3/4	.125	.093	.33
52103	53222	3.00	13.00	1/4-20	1	.187	.119	.70
52108	53227	3.00	13.00	1/4-28	1	.187	.118	.70
52109	53228	2.00	9.00	1/4-20	3/4	.125	.118	.70
52104	53223	3.00	15.00	5/16-18	1	.187	.135	1.20
52105	53224	5.50	14.50	3/8-16	1-1/8	.187	.186	1.80
52106	53225	6.60	17.40	1/2-13	1-1/4	.250	.248	3.80
52107	53226	10.60	25.50	5/8-11	1-1/2	.312	.310	7.00

- Steel Body Plungers:
 - 12L14 Steel Body
 - Black Oxide Finish
 - Black Delrin Nose
- Stainless Steel Body Plungers:
 - 303 Stainless Steel Body
 - Black Delrin Nose
- Insulating Delrin Plungers
- Ideal for aluminum, brass, or any soft, easily marred material.

Phelonic Nose

Steel Part No.	End Force (lbs)		Thread A	B	C	+.000 -.002 D	Weight (lbs/100pcs)
	Initial	Final					
57401	2.70	7.30	8-32	5/8	.093	.070	.20
57402	2.90	11.10	10-32	3/4	.125	.092	.33
57403	3.00	13.00	1/4-20	1	.187	.118	.70
57404	3.00	13.00	1/4-28	1	.187	.118	.70
57405	3.00	15.00	5/16-18	1	.187	.135	1.20
57406	5.50	14.50	3/8-16	1-1/8	.187	.187	1.80
57407	6.60	17.40	1/2-13	1-1/4	.250	.248	3.80
57408	10.50	25.50	5/8-11	1-1/2	.312	.310	7.00

- Steel Body Plungers:
 - 12L14 Steel Body
 - Black Oxide Finish
 - Brown Phenolic Nose
- Ideal for aluminum, brass, or any soft, easily marred material.
- High tensile strength
- Excellent wear resistance

Special sizes quoted upon request – see quotation sheet on page 112.

NYLON THREAD LOCKING ELEMENT IS STANDARD ON ALL SIZES

To order ball plungers without a locking element, simply add an "X" to the end of the part number (ex. 52821X). Pricing is the same with or without locking element.

GENERAL INFORMATION

- Metric sizes available, see page 101
- Many sizes conform to TCMAI standards
- Typical uses: positioning, locating, ejecting, detents, contacts, lifters, insulators, and latches
- Easy installation

Standard Spring Plungers

- Carbon & Stainless Steel Bodies
- Light End Forces

For information concerning installation, see page 111.

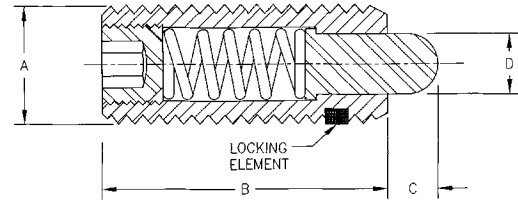

Carbon & Stainless Steel Nose

Steel Part No.	Stainless Steel Part No.	End Force (lbs)		Thread A	B	C	+.000 -.001 D	Weight (lbs/100pcs)
		Initial	Final					
52201	53301	.50	1.50	6-32	17/32	.062	.046	.10
52202	53302	.70	2.30	8-32	5/8	.093	.070	.22
52203	53303	1.30	2.70	10-32	3/4	.125	.093	.37
52217	53308	.25	2.00	1/4-20	3/4	.125	.119	.65
52204	53305	1.00	4.00	1/4-20	1	.187	.119	.75
52205	53306	1.00	4.00	1/4-28	1	.187	.119	.75
52206	53304	1.50	4.50	5/16-18	1	.187	.135	1.40
52207	53307	2.80	7.20	3/8-16	1-1/8	.187	.186	2.00
52208	53309	2.70	9.30	1/2-13	1-1/4	.250	.248	4.50
52209	53310	3.50	10.50	5/8-11	1-1/2	.312	.310	8.00
52210	53311	4.00	16.00	3/4-10	1-3/4	.312	.374	14.00
52211	53312	4.00	31.00	1-8	2-13/32	.500	.499	32.00

- Steel Body Plungers:
 - 12L14 Steel Body
 - Black Oxide Finish
 - Case Hardened 12L14 Steel Nose, Zinc Plated
- Stainless Steel Body Plungers:
 - 303 Stainless Steel Body and Nose
- Excellent wear resistance

White Delrin® Nose

Steel Part No.	Stainless Steel Part No.	End Force (lbs)		Thread A	B	C	+.000 -.002 D	Weight (lbs/100pcs)
		Initial	Final					
52301	53313	.70	2.30	8-32	5/8	.093	.070	.20
52302	53314	1.30	2.70	10-32	3/4	.125	.093	.33
52309	53321	.25	2.00	1/4-20	3/4	.125	.119	.65
52303	53315	1.00	4.00	1/4-20	1	.187	.119	.70
52308	53320	1.00	4.00	1/4-28	1	.187	.118	.70
52304	53316	1.50	4.50	5/16-18	1	.187	.135	1.20
52305	53317	2.80	7.20	3/8-16	1-1/8	.187	.186	1.80
52306	53318	2.70	9.30	1/2-13	1-1/4	.250	.248	3.80
52307	53319	3.50	10.50	5/8-11	1-1/2	.312	.310	7.00

- Steel Body Plungers:
 - 12L14 Steel Body
 - Black Oxide Finish
 - White Delrin Nose
- Stainless Steel Body Plungers:
 - 303 Stainless Steel Body
 - White Delrin Nose
- Insulating Delrin Plungers
- Ideal for aluminum, brass, or any soft, easily marred material.

Phelonic Nose

Steel Part No.	End Force (lbs)		Thread A	B	C	+.000 -.002 D	Weight (lbs/100pcs)
	Initial	Final					
57409	0.70	2.30	8-32	5/8	.093	.070	.20
57410	1.30	2.70	10-32	3/4	.125	.092	.33
57411	1.00	4.00	1/4-20	1	.187	.118	.70
57412	1.00	4.00	1/4-28	1	.187	.118	.70
57413	1.50	4.50	5/16-18	1	.187	.135	1.20
57414	2.80	7.20	3/8-16	1-1/8	.187	.187	1.80
57415	2.70	9.30	1/2-13	1-1/4	.250	.248	3.80
57416	3.50	10.50	5/8-11	1-1/2	.312	.310	7.00

- Steel Body Plungers:
 - 12L14 Steel Body
 - Black Oxide Finish
 - Brown Phenolic Nose
- Ideal for aluminum, brass, or any soft, easily marred material.
- High tensile strength
- Excellent wear resistance

Special sizes quoted upon request – see quotation sheet on page 112.

NYLON THREAD LOCKING ELEMENT IS STANDARD ON ALL SIZES

To order ball plungers without a locking element, simply add an "X" to the end of the part number (ex. 52821X). Pricing is the same with or without locking element.

GENERAL INFORMATION

- Metric sizes available, see page 101
- Many sizes conform to TCMAI standards
- Typical uses: positioning, locating, ejecting, detents, contacts, lifters, insulators, and latches
- Easy installation

Short Spring Plungers

- Carbon & Stainless Steel Bodies
- Heavy End Forces

For information concerning installation, see page 111.

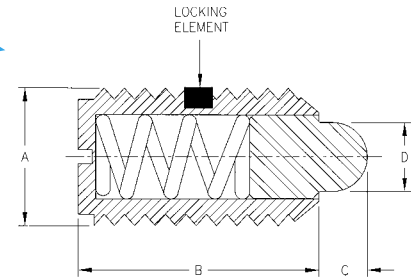

Carbon & Stainless Steel Nose

Steel Part No.	Stainless Steel Part No.	End Force (lbs)		Thread A	B	C	+.000 -.001 D	Weight (lbs/100pcs)
		Initial	Final					
52408	53408	.50	3.50	6-32	3/8	.036	.046	.12
52409	53409	1.50	4.75	8-32	7/16	.052	.070	.12
52401	53401	1.50	4.75	8-36	7/16	.052	.069	.15
52402	53402	1.75	6.25	10-32	15/32	.065	.093	.16
52403	53403	3.00	10.50	1/4-20	17/32	.078	.119	.40
52404	53404	3.75	15.50	5/16-18	9/16	.084	.135	.60
52405	53405	4.50	18.50	3/8-16	5/8	.110	.186	.90
52406	53406	5.00	28.00	1/2-13	3/4	.151	.248	2.50
52407	53407	7.00	50.00	5/8-11	1-1/16	.215	.310	6.00

- Steel Body Plungers:
 - 12L14 Steel Body
 - Black Oxide Finish
 - Case Hardened 12L14 Steel Nose, Black Oxide
- Stainless Steel Body Plungers:
 - 303 Stainless Steel Body and Nose
- Excellent wear resistance

Carbon Steel Nose – Metric **NEW!**

Steel Part No.	End Force (lbs)		Thread A	B	C	+.000 -.025 D	Weight (lbs/100pcs)
	Initial	Final					
64101	.50	4.00	M4 x 0.7	13.0	2.5	1.78	.12
64102	.50	5.00	M5 x 0.8	14.5	3.0	2.36	.16
64103	.50	6.00	M6 x 1.0	16.0	4.0	3.02	.40
64104	.50	10.00	M8 x 1.25	16.0	5.0	3.43	.60
64105	1.00	12.00	M10 x 1.5	17.5	5.5	4.72	.90
64106	2.50	14.90	M12 x 1.75	20.5	6.5	6.30	2.50
64107	3.50	25.80	M16 x 2.0	28.5	8.0	7.87	6.00

Metric Plungers dimensioned in millimeters unless otherwise noted

- Steel Body Plungers:
 - 12L14 Steel Body
 - Black Oxide Finish
 - Case Hardened 12L14 Steel Nose, Zinc Plated
- Excellent wear resistance

Black Delrin® Nose

Steel Part No.	Stainless Steel Part No.	End Force (lbs)		Thread A	B	C	+.000 -.002 D	Weight (lbs/100pcs)
		Initial	Final					
52508	53427	0.50	3.50	6-32	3/8	.036	.046	.12
52509	53428	1.50	4.75	8-32	7/16	.052	.070	.12
52501	53420	1.50	4.75	8-36	7/16	.052	.070	.15
52502	53421	1.75	6.25	10-32	15/32	.065	.093	.16
52503	53422	3.00	10.50	1/4-20	17/32	.078	.119	.40
52504	53423	3.75	15.50	5/16-18	9/16	.084	.135	.60
52505	53424	4.50	18.50	3/8-16	5/8	.110	.186	.90
52506	53425	5.00	28.00	1/2-13	3/4	.151	.248	2.00
52507	53426	7.00	50.00	5/8-11	1-1/16	.215	.310	4.60

- Steel Body Plungers:
 - 12L14 Steel Body
 - Zinc Plated Clear Chromate Finish
 - Black Delrin Nose
- Stainless Steel Body Plungers:
 - 303 Stainless Steel Body
 - Black Delrin Nose
- Insulating Delrin Plungers
- Ideal for aluminum, brass, or any soft, easily marred material.

Blue Delrin® Nose – Metric **NEW!**

Steel Part No.	End Force (lbs)		Thread A	B	C	+.000 -.050 D	Weight (lbs/100pcs)
	Initial	Final					
64115	.50	4.00	M4 x 0.7	13.0	2.5	1.78	.12
64116	.50	5.00	M5 x 0.8	14.5	3.0	2.36	.16
64117	.50	6.00	M6 x 1.0	16.0	4.0	3.02	.40
64118	.50	10.00	M8 x 1.25	16.0	5.0	3.43	.60
64119	1.00	12.00	M10 x 1.5	17.5	5.5	4.72	.90
64120	2.50	14.90	M12 x 1.75	20.5	6.5	6.30	2.50
64121	3.50	25.80	M16 x 2.0	28.5	8.0	7.87	6.00

Metric Plungers dimensioned in millimeters unless otherwise noted

- Steel Body Plungers:
 - 12L14 Steel Body
 - Blue Delrin Nose
- Insulating Delrin Plungers
- Ideal for aluminum, brass, or any soft, easily marred material.

Special sizes quoted upon request – see quotation sheet on page 112.

Short Spring Plungers

- Carbon & Stainless Steel Bodies
- Light End Forces

For information concerning installation, see page 111.

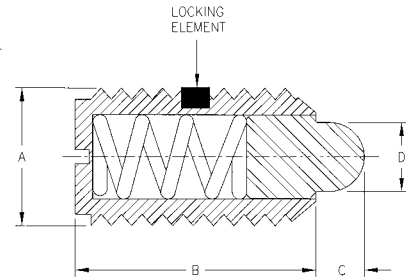

Carbon & Stainless Steel Nose

Steel Part No.	Stainless Steel Part No.	End Force (lbs)		Thread A	B	C	+.000 -.001 D	Weight (lbs/100pcs)
		Initial	Final					
52608	53508	.50	1.50	6-32	3/8	.036	.046	.12
52609	53509	.50	1.50	8-32	7/16	.052	.070	.12
52601	53501	.50	1.50	8-36	7/16	.052	.069	.15
52602	53502	.75	2.50	10-32	15/32	.065	.093	.16
52603	53503	1.00	3.50	1/4-20	17/32	.078	.119	.40
52604	53504	1.50	4.00	5/16-18	9/16	.084	.135	.60
52605	53505	1.50	5.00	3/8-16	5/8	.110	.186	.90
52606	53506	1.75	5.50	1/2-13	3/4	.151	.248	2.50
52607	53507	2.00	8.50	5/8-11	1-1/16	.215	.310	6.00

- Steel Body Plungers:
 - 12L14 Steel Body
 - Black Oxide Finish
 - Case Hardened 12L14 Steel Nose, Zinc Plated
- Stainless Steel Body Plungers:
 - 303 Stainless Steel Body and Nose
- Excellent wear resistance

Carbon Steel Nose – Metric **NEW!**

Steel Part No.	End Force (lbs)		Thread A	B	C	+.000 -.025 D	Weight (lbs/100pcs)
	Initial	Final					
64108	.50	2.00	M4 x 0.7	13.0	2.5	1.78	.12
64109	.30	3.00	M5 x 0.8	14.5	3.0	2.36	.16
64110	.30	3.50	M6 x 1.0	16.0	4.0	3.02	.40
64111	.50	4.50	M8 x 1.25	16.0	5.0	3.43	.60
64112	1.50	7.45	M10 x 1.5	17.5	5.5	4.72	.90
64113	1.70	8.45	M12 x 1.75	20.5	6.5	6.30	2.50
64114	2.00	10.40	M16 x 2.0	28.5	8.0	7.87	6.00

Metric Plungers dimensioned in millimeters unless otherwise noted

- Steel Body Plungers:
 - 12L14 Steel Body
 - Black Oxide Finish
 - Case Hardened 12L14 Steel Nose, Zinc Plated
- Excellent wear resistance

White Delrin® Nose

Steel Part No.	Stainless Steel Part No.	End Force (lbs)		Thread A	B	C	+.000 -.002 D	Weight (lbs/100pcs)
		Initial	Final					
52708	53527	0.50	1.50	6-32	3/8	.036	.046	.12
52709	53528	0.50	1.50	8-32	7/16	.052	.070	.12
52701	53520	0.50	1.50	8-36	7/16	.052	.070	.12
52702	53521	0.75	2.50	10-32	15/32	.065	.093	.16
52703	53522	1.00	3.50	1/4-20	17/32	.078	.119	.40
52704	53523	1.50	4.00	5/16-18	9/16	.084	.135	.60
52705	53524	1.50	5.00	3/8-16	5/8	.110	.186	.90
52706	53525	1.75	5.50	1/2-13	3/4	.151	.248	2.00
52707	53526	2.00	8.50	5/8-11	1-1/16	.215	.310	4.60

- Steel Body Plungers:
 - 12L14 Steel Body
 - Zinc Plated Clear Chromate
 - White Delrin Nose
- Stainless Steel Body Plungers:
 - 303 Stainless Steel Body
 - White Delrin Nose
- Insulating Delrin Plungers
- Ideal for aluminum, brass, or any soft, easily marred material.

White Delrin® Nose – Metric **NEW!**

Steel Part No.	End Force (lbs)		Thread A	B	C	+.000 -.050 D	Weight (lbs/100pcs)
	Initial	Final					
64122	.50	4.00	M4 x 0.7	13.0	2.5	1.78	.12
64123	.50	5.00	M5 x 0.8	14.5	3.0	2.36	.16
64124	.50	6.00	M6 x 1.0	16.0	4.0	3.02	.40
64125	.50	10.00	M8 x 1.25	16.0	5.0	3.43	.60
64126	1.00	12.00	M10 x 1.5	17.5	5.5	4.72	.90
64127	2.50	14.90	M12 x 1.75	20.5	6.5	6.30	2.50
64128	3.50	25.80	M16 x 2.0	28.5	8.0	7.87	6.00

Metric Plungers dimensioned in millimeters unless otherwise noted

- Steel Body Plungers:
 - 12L14 Steel Body
 - White Delrin Nose
- Insulating Delrin Plungers
- Ideal for aluminum, brass, or any soft, easily marred material.

Special sizes quoted upon request – see quotation sheet on page 112.

Shortie Spring Plungers – Long Travel

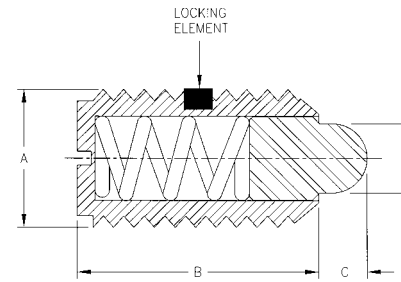

Heavy End Force

Steel Part No.	Delrin Nose Part No.	End Force (lbs)		Thread A	B	C	D
		Initial	Final				
52410	52418	.50	3.50	6-32	3/8	1/16	.046
52411	52419	.50	4.00	8-32	1/2	3/32	.070
52412	52420	.50	5.00	10-32	9/16	1/8	.093
52413	52421	.50	6.00	1/4-20	5/8	3/16	.119
52414	52422	.50	10.00	5/16-18	5/8	3/16	.135
52415	52423	1.00	12.00	3/8-16	11/16	3/16	.186
52416	52424	2.50	15.00	1/2-13	13/16	1/4	.248
52417	52425	3.50	26.00	5/8-11	1-1/8	5/16	.310

- Material:
 - Body: Low Carbon Steel, Black Oxide Finish
 - Nose:
 - Steel:
 - Light Force = Zinc Plated Clear Chromate
 - Heavy Force = Black Oxide Finish
 - Delrin:
 - Light Force = White
 - Heavy Force = Blue

Light End Force

Steel Part No.	Delrin Nose Part No.	End Force (lbs)		Thread A	B	C	D
		Initial	Final				
52610	52618	.50	1.50	6-32	3/8	1/16	.046
52611	52619	.50	2.00	8-32	1/2	3/32	.070
52612	52620	.50	3.00	10-32	9/16	1/8	.093
52613	52621	.50	3.50	1/4-20	5/8	3/16	.119
52614	52622	.50	4.50	5/16-18	5/8	3/16	.135
52615	52623	1.00	7.50	3/8-16	11/16	3/16	.186
52616	52624	2.50	8.50	1/2-13	13/16	1/4	.248
52617	52625	3.50	10.50	5/8-11	1-1/8	5/16	.310

- Short plungers offer a longer nose than standard short spring plungers
- **All Long Travel Shortie Spring Plungers have a nylon patch**

Metric Spring Plungers

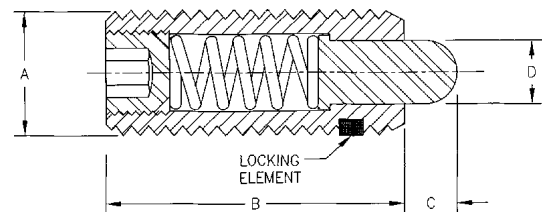

Steel Part No.	Stainless Steel Part No.	End Force (lbs)		Thread A	B mm (in.)	C mm (in.)	D mm (in.)
		Initial	Final				
63701	63720	4.00	11.15	M6 x 1.0	20 (.787)	2.5 (.098)	2.7 (.106)
63702	63721	5.60	15.60	M8 x 1.25	22 (.866)	3 (.118)	3.5 (.138)
63703	63722	5.60	15.60	M10 x 1.50	22 (.866)	3 (.118)	4 (.157)
63704	63723	10.00	24.50	M12 x 1.75	28 (1.102)	4 (.157)	6 (.236)
63705	63724	1.60	4.50	M6 x 1.0	20 (.787)	2.5 (.098)	2.7 (.106)
63706	63725	2.00	7.80	M8 x 1.25	22 (.866)	3 (.118)	3.5 (.138)
63707	63726	2.00	7.80	M10 x 1.50	22 (.866)	3 (.118)	4 (.157)
63708	63727	2.25	12.30	M12 x 1.75	28 (1.102)	4 (.157)	6 (.236)

- Material:
 - Steel Body: 12L14 Steel, Black Oxide Finish
 - Stainless Steel Body: 303 Stainless Steel
 - Steel Nose: 12L14 Steel, Black Oxide Finish
 - Stainless Steel Nose: 303 Stainless Steel
- Many sizes conform to TCMAI standards
- All dimensions in metric format

NYLON THREAD LOCKING ELEMENT IS STANDARD ON ALL SIZES

To order ball plungers without a locking element, simply add an "X" to the end of the part number (ex. 52821X). Pricing is the same with or without locking element.

Posi Hex Plungers

- Material:
 - Steel Body: 12L14 Steel
 - Stainless Steel Body: 303 Stainless Steel
 - Steel Plunger: 12L14 Steel, Case Hardened
 - Stainless Steel Plunger: 303 Stainless Steel
- Heavy End Force: Black Oxide Finish
- Light End Force: Zinc Plated Nose
- Easy installation and removal
- Withstands high torque
- One-piece body – no set screw in back

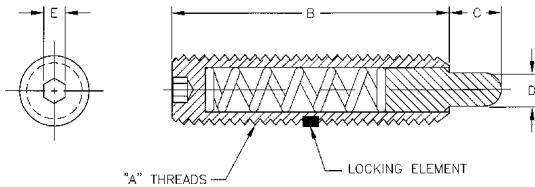

METRIC Heavy End Force

STEEL BODY		End Force (lbs)		Thread A	B	C	D*	E
Steel Nose Part No.	Delrin Nose Part No.	Initial	Final					
67001	67080	2.70	7.30	M4 x 0.7	16	2.5	1.78	2
67002	67081	2.90	11.10	M5 x 0.8	19	3.0	2.36	2.5
67003	67082	3.00	13.00	M6 x 1.0	25	5.0	3.02	3
67004	67083	3.00	15.00	M8 x 1.25	25	5.0	3.43	4
67005	67084	5.50	14.50	M10 x 1.5	29	5.0	4.72	5
67006	67085	6.60	17.40	M12 x 1.75	32	6.0	6.30	6
67007	67086	10.50	25.50	M16 x 2.0	38	8.0	7.87	8
67008	67087	6.70	37.30	M20 x 2.5	44	8.0	9.50	10

Light End Force

STEEL BODY		End Force (lbs)		Thread A	B	C	D*	E
Steel Nose Part No.	Delrin Nose Part No.	Initial	Final					
67009	67088	.70	2.30	M4 x 0.7	16	2.5	1.78	2
67010	67089	1.30	2.70	M5 x 0.8	19	3.0	2.36	2.5
67011	67090	1.00	4.00	M6 x 1.0	25	5.0	3.02	3
67012	67091	1.50	4.50	M8 x 1.25	25	5.0	3.43	4
67013	67092	2.80	7.20	M10 x 1.5	29	5.0	4.72	5
67014	67093	2.70	9.30	M12 x 1.75	32	6.0	6.30	6
67015	67094	3.50	10.50	M16 x 2.0	38	8.0	7.87	8
67016	67095	4.00	16.00	M20 x 2.5	44	8.0	9.50	10

ENGLISH Heavy End Force

STEEL BODY		STAINLESS BODY		End Force (lbs)		Thread A	B	C	D*	E
Steel Nose Part No.	Delrin Nose Part No.	Stainless Nose Part No.	Initial	Final						
57001	57085	57015	1.5	4.5	6-32	17/32	1/16	.045	1/16	
57002	-	57016	1.0	1.6	6-32	1/2	1/16	.045	1/16	
57003	57086	57017	2.7	7.3	8-32	5/8	3/32	.070	1/16	
57004	57087	57018	2.9	11.1	10-32	3/4	1/8	.092	1/16	
57005	57088	57019	3.0	13.0	1/4-20	1	3/16	.118	5/64	
57006	57089	57020	3.0	13.0	1/4-28	1	3/16	.118	5/64	
57007	-	57021	2.0	9.0	1/4-20	3/4	1/8	.118	5/64	
57008	57090	57022	3.0	15.0	5/16-18	1	3/16	.135	3/32	
57080	57091	-	5.5	14.5	3/8-16	1-1/8	3/16	.186	3/16	
57081	57092	-	6.6	17.4	1/2-13	1-1/4	1/4	.248	1/4	
57082	57093	-	10.5	25.5	5/8-11	1-1/2	5/16	.310	5/16	
57083	-	-	6.7	37.3	3/4-10	1-3/4	5/16	.374	3/8	



Light End Force

STEEL BODY		STAINLESS BODY		End Force (lbs)		Thread A	B	C	D*	E
Steel Nose Part No.	Delrin Nose Part No.	Stainless Nose Part No.	Initial	Final						
57009	57185	57023	0.5	1.5	6-32	17/32	1/16	.045	1/16	
57010	57186	57024	0.7	2.3	8-32	5/8	3/32	.070	1/16	
57011	57187	57025	1.3	2.7	10-32	3/4	1/8	.092	1/16	
57012	57188	57026	1.0	4.0	1/4-20	1	3/16	.118	5/64	
57013	57189	57027	1.0	4.0	1/4-28	1	3/16	.118	5/64	
57014	57190	57028	1.5	4.5	5/16-18	1	3/16	.135	3/32	
57180	57191	-	2.8	7.2	3/8-16	1-1/8	3/16	.186	3/16	
57181	57192	-	2.7	9.3	1/2-13	1-1/4	1/4	.248	1/4	
57182	57193	-	3.5	10.5	5/8-11	1-1/2	5/16	.310	5/16	
57183	-	-	5.5	14.5	3/4-10	1-3/4	5/16	.374	3/8	
57184**	-	-	10.0	25.0	1-8	2-13/32	1/2	.499	3/8	

* INCH SIZES

Steel Nose: +.000, -.001

Delrin Nose: +.000, -.002

* METRIC SIZES

Steel Nose: +.000, -.025

Delrin Nose: +.000, -.050

**Not available in one-piece design

Flat Hex Nose Plungers

- Material: Steel, Black Oxide Finish
- Ideal for tough, high-speed, long-life product applications
- Flat, hexagonal nose design
- Easy access and adjustment
- Long spring life

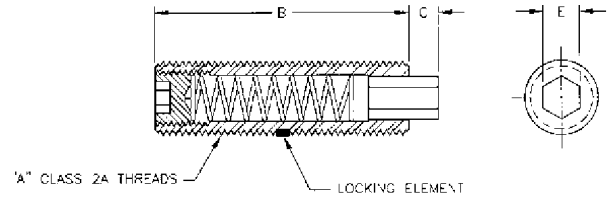
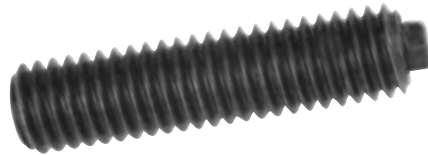

Part No.	End Force (lbs)		Thread A	B	C	E
	Initial	Final				
57301	0.50	6-1/8	1/4-20	1.343	.078	1/8
57302	0.50	8	5/16-18	1.406	.088	1/8
57303	0.50	9-7/8	3/8-16	1.532	.097	3/16
57304	0.50	16	1/2-13	1.718	.105	1/4

Long Travel Hex Nose Plungers

- Material: Steel
- Ideal for high-speed, long-life applications
- Hexagonal nose design
- Easy insertion, adjustment or removal

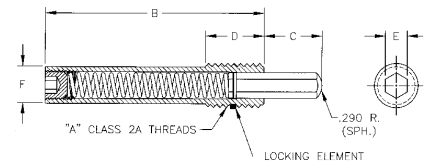

Body & Nose: Black Oxide Finish Heavy End Force

Part No.	End Force (lbs)		Thread A	B	C	D	E	F
	Initial	Final						
57301	0.50	6-1/8	1/4-20	1.343	.078	1/8		
57101	4.0	20.0	5/8-11	3.12	1.00	1.25	.31	.510
57102	4.0	35.0	3/4-10	3.75	1.00	1.50	.38	.623
57103	16	50-3/4	1-8	5.00	1.00	2.00	.50	.844
57104	16	68	1-8	5.00	1.50	2.00	.50	.844

Body: Black Oxide Finish/Nose: Zinc Plated Light End Force

Part No.	End Force (lbs)		Thread A	B	C	D	E	F
	Initial	Final						
57105	4.0	22	1-8	5	1.00	2.00	.50	.844
57106	4.0	31	1-8	5	1.00	2.00	.50	.844

Hex Nose Plungers

- Material: Steel, Black Oxide Finish
- Case hardened plunger
- Heavy End Force: Black Oxide Finish
- Light End Force: Zinc Plated Nose
- Hexagonal nose design allows for easy installation/removal with socket wrench

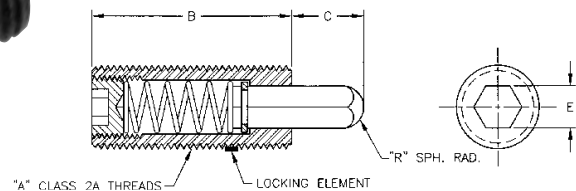

Heavy End Force

Part No.	End Force (lbs)		Thread A	B	C	E	R
	Initial	Final					
57201	3.0	13.0	1/4-20	1	3/16	1/8	.071
57202	3.0	15.0	5/16-18	1	3/16	1/8	.071
57203	5.5	14.5	3/8-16	1-1/8	3/16	3/16	.108
57204	6.6	17.4	1/2-13	1-1/4	1/4	1/4	.144
57205	10.5	25.5	5/8-11	1-1/2	5/16	5/16	.179
57206	6.7	37.3	3/4-10	1-3/4	5/16	3/8	.215
57207	16.0	68.0	1-8	2-13/32	1/2	1/2	.290

Light End Force

Part No.	End Force (lbs)		Thread A	B	C	E	R
	Initial	Final					
57210	1.0	4.0	1/4-20	1	3/16	1/8	.071
57211	1.5	4.5	5/16-18	1	3/16	1/8	.071
57212	2.8	7.2	3/8-16	1-1/8	3/16	3/16	.108
57213	2.7	9.3	1/2-13	1-1/4	1/4	1/4	.144
57214	3.5	10.5	5/8-11	1-1/2	5/16	5/16	.179
57215	4.0	31.0	1-8	2-13/32	1/2	1/2	.290

Delrin® Knob Steel Hand Retractable Spring Plungers: Non-Locking

- Material:
 - Body: Steel
 - Plunger: Case Hardened Steel
 - Knob: Delrin (Black)
- Non-locking design
- Contoured knob
- Unified ANSI & metric threads

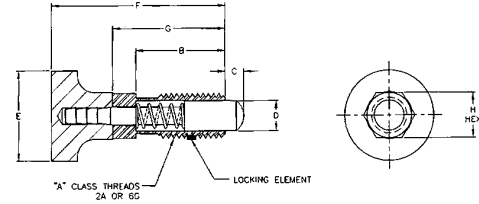

Steel

Part No.	End Force (lbs)		Thread A	B	C	D	E	F	G	Hex H
	Initial	Final								
58350*	.12	.36	1/4-20	.50	.13	.16	.50	.97	.63	1/4
58351	.25	2.0	3/8-16	.75	.18	.25	.75	1.4	.94	3/8
58352	.50	1.75	1/2-13	1.0	.25	.31	1.0	1.9	1.25	1/2

*No thread relief in 1/4-20 thread size
Initial End Forces = +/-50% Final End Forces = +/-25%

Steel – Metric

Part No.	End Force (lbs)		Thread A mm (in.)	B mm (in.)	C mm (in.)	D mm (in.)	E mm (in.)	F mm (in.)	G mm (in.)	Hex H mm (in.)
	Initial	Final								
68350*	.11	.34	M6 x 1.0	13 (.50)	3 (.118)	3 (.117)	12 (.48)	25 (.98)	16 (.63)	6 (.236)
68351	.22	2.02	M10 x 1.5	20 (.79)	5 (.196)	6 (.236)	19 (.75)	38 (1.5)	25 (.98)	10 (.39)
68352	.56	1.80	M12 x 1.75	25 (.98)	6 (.236)	8 (.314)	25 (.98)	47 (1.85)	31 (1.2)	12(.472)

*No thread relief in M6 thread size

Delrin® Knob Steel Hand Retractable Spring Plungers: Locking

- Material:
 - Body: Steel
 - Plunger: Case Hardened Steel
 - Knob: Delrin (Black)
- Optional locking element
- Contoured knob
- Unified ANSI & metric threads

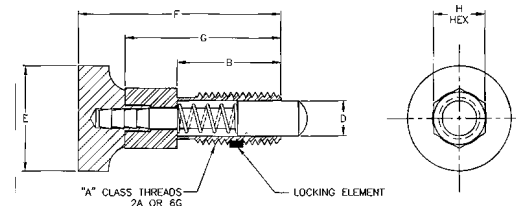

Steel

Part No.	End Force (lbs)		Thread A	B	C	D	E	F	G	Hex H
	Initial	Final								
58301*	.12	.36	1/4-20	.50	.13	.16	.50	.97	.75	1/4
58302	.25	2.0	3/8-16	.75	.18	.25	.75	1.4	1.13	3/8
58303	.50	1.75	1/2-13	1.0	.25	.31	1.0	1.9	1.50	1/2

*No thread relief in 1/4-20 thread size
Initial End Forces = +/-50% Final End Forces = +/-25%

Steel – Metric

Part No.	End Force (lbs)		Thread A mm (in.)	B mm (in.)	C mm (in.)	D mm (in.)	E mm (in.)	F mm (in.)	G mm (in.)	Hex H mm (in.)
	Initial	Final								
68301*	.11	.34	M6 x 1.0	13 (.50)	3 (.118)	3 (.117)	12 (.48)	25 (.98)	19	6 (.236)
68302	.22	2.02	M10 x 1.5	20 (.79)	5 (.196)	6 (.236)	19 (.75)	38 (1.5)	30	10 (.39)
68303	.56	1.80	M12 x 1.75	25 (.98)	6 (.236)	8 (.314)	25 (.98)	47 (1.85)	37	12(.472)

NYLON THREAD LOCKING ELEMENT IS STANDARD ON ALL SIZES
To order ball plungers without a locking element, simply add an "X" to the end of the part number (ex. 52821X). Pricing is the same with or without locking element.

Delrin® Knob Stainless Steel Hand Retractable Spring Plungers: Non-Locking

- Material:
 - Body: Stainless Steel
 - Plunger: Stainless Steel
 - Knob: Delrin
- Contoured knob
- Unified ANSI & metric threads
- Ideal for food and medical applications

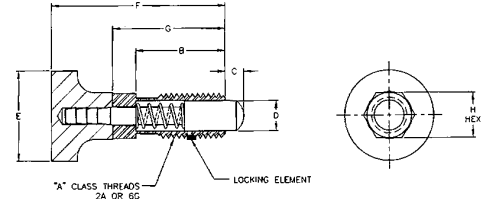

Stainless Steel

Part No.	End Force (lbs)		Thread A	B	C	D	E	F	G	Hex H
	Initial	Final								
58450*	.12	.36	1/4-20	.50	.13	.16	.50	.97	.63	1/4
58451	.25	2.0	3/8-16	.75	.18	.25	.75	1.4	.94	3/8
58452	.50	1.75	1/2-13	1.0	.25	.31	1.0	1.9	1.25	1/2

*No thread relief in 1/4-20 thread size
Initial End Forces = +/-50% Final End Forces = +/-25%

Stainless Steel – Metric

Part No.	End Force (lbs)		Thread A mm (in.)	B mm (in.)	C mm (in.)	D mm (in.)	E mm (in.)	F mm (in.)	G mm (in.)	Hex H mm (in.)
	Initial	Final								
68450*	.11	.34	M6 x 1.0	13 (.50)	3 (.118)	3 (.117)	12 (.48)	25 (.98)	16 (.63)	6 (.236)
68451	.22	2.02	M10 x 1.5	20 (.79)	5 (.196)	6 (.236)	19 (.75)	38 (1.5)	25 (.98)	10 (.39)
68452	.56	1.80	M12 x 1.75	25 (.98)	6 (.236)	8 (.314)	25 (.98)	47 (1.85)	31 (1.2)	12(.472)

*No thread relief in M6 thread size

Delrin® Knob Stainless Steel Hand Retractable Spring Plungers: Locking

- Material:
 - Body: Stainless Steel
 - Plunger: Stainless Steel
 - Knob: Delrin
- Contoured knob
- Unified ANSI & metric threads

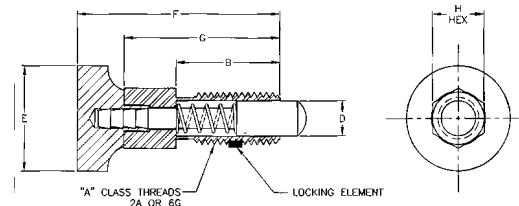

Stainless Steel

Part No.	End Force (lbs)		Thread A	B	C	D	E	F	G	Hex H
	Initial	Final								
58401*	.12	.36	1/4-20	.50	.13	.16	.50	.97	.75	1/4
58402	.25	2.0	3/8-16	.75	.18	.25	.75	1.4	1.13	3/8
58403	.50	1.75	1/2-13	1.0	.25	.31	1.0	1.9	1.50	1/2

*No thread relief in 1/4-20 thread size
Initial End Forces = +/-50% Final End Forces = +/-25%

Stainless Steel – Metric

Part No.	End Force (lbs)		Thread A mm (in.)	B mm (in.)	C mm (in.)	D mm (in.)	E mm (in.)	F mm (in.)	G mm (in.)	Hex H mm (in.)
	Initial	Final								
68401*	.11	.34	M6 x 1.0	13 (.50)	3 (.118)	3 (.117)	12 (.48)	25 (.98)	19	6 (.236)
68402	.22	2.02	M10 x 1.5	20 (.79)	5 (.196)	6 (.236)	19 (.75)	38 (1.5)	30	10 (.39)
68403	.56	1.80	M12 x 1.75	25 (.98)	6 (.236)	8 (.314)	25 (.98)	47 (1.85)	37	12(.472)

*No thread relief in M6 thread size

NYLON THREAD LOCKING ELEMENT IS STANDARD ON ALL SIZES
To order ball plungers without a locking element, simply add an "X" to the end of the part number (ex. 52821X). Pricing is the same with or without locking element.

Knurled Knob Hand Retractable Spring Plungers Steel & Stainless Steel: Non-Locking

- Material:
 - Body: Steel or Stainless Steel
 - Plunger: Steel or Stainless Steel
- Unified ANSI and metric threads
- Hand retractable plunger can be easily engaged and withdrawn
- Chamfered plunger for easy alignment
- Built-in drive wrench for rapid installation and alignment

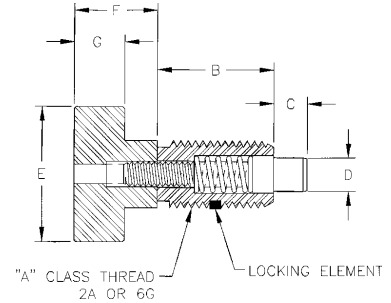

Steel* Black Part No.	Steel** Yellow Part No.	Stainless Steel Part No.	End Force (lbs)		Thread A	B	C	+.001 -.001 D	E	F	G	Weight (lbs/100pcs)
			Initial	Final								
-	54654	54505	.50	3.0	10-32	.400	.094	.104***	0.38	.250	.190	2
54601	54650	54501	1.00	4.00	1/4-20	.500	.125	.123	0.50	.313	.190	2
54602	54651	54502	1.00	6.00	5/16-18	.625	.188	.154	0.63	.375	.250	4
54603	54652	54503	1.00	8.00	3/8-16	.750	.218	.185	0.75	.500	.310	6
54604	54653	54504	1.00	10.00	1/2-13	.875	.250	.248	1.00	.625	.380	8

*Black Oxide Finish **Zinc Plated Yellow Chromate Finish ***Radiused Nose

METRIC

Steel** Part No.	Stainless Steel Part No.	End Force (lbs)		Thread A	B mm (in.)	C mm (in.)	D* mm (in.)	E mm (in.)	F mm (in.)	G mm (in.)
		Initial	Final							
64601	64501	0.5	3.0	M5 x 0.8	10 (.394)	2 (.078)	2.5 (.0984)	9(.355)	6 (.236)	4 (.157)
64602	64502	1.0	4.0	M6 x 1.0	13 (.512)	3 (.118)	3 (.118)	13 (.512)	8 (.315)	5 (.197)
64603	64503	1.0	8.0	M10 x 1.5	19 (.748)	6 (.236)	5 (.1968)	19 (.748)	13 (.512)	8 (.315)
64604	64504	1.0	10.0	M12 x 1.75	23 (.905)	6 (.236)	6 (.236)	25 (.984)	16 (.630)	10 (.315)

*Tolerance: +.000; -.0254 (+.000; -.001) **Zinc Plated Yellow Chromate Finish

**NYLON THREAD
LOCKING ELEMENT IS
STANDARD ON ALL SIZES**
To order ball plungers
without a locking
element, simply add
an "X" to the end of
the part number (ex.
52821X). Pricing is the
same with or without
locking element.

Knurled Knob Hand Retractable Spring Plungers Steel & Stainless Steel: Locking

- Material:
 - Body: Steel or Stainless Steel
 - Plunger: Steel or Stainless Steel
- Unified ANSI and metric threads
- Hand retractable plunger can be easily engaged and withdrawn
- Chamfered plunger for easy alignment
- Built-in drive wrench for rapid installation and alignment
- Plunger can be completely withdrawn into the body and locked into a retracted position

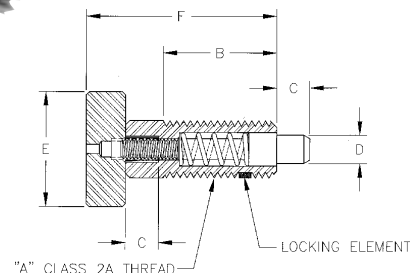

Steel Part No.*	Stainless Steel Part No.	End Force (lbs)		Thread A	B	C	+.001 -.001 D	E	F	Weight (lbs/100pcs)
		Initial	Final							
54610	54510	.50	2.0	1/4-20	.400	.125	.123	.50	.805	2
54611	54511	.50	3.0	3/8-16	.750	.22	.185	.75	1.26	6
54612	54512	.50	4.0	1/2-13	.650	.25	.248	1.0	1.38	8

*Zinc Plated Yellow Chromate Finish

Hex Drive Knob Retractable: Locking

- Zinc gold chromate finish
- Hand-retractable locking plunger
- Withstands side loading
- Chamfered for easy alignment
- Built in hex drive wrench
- Plunger can be completely withdrawn into the body and locked into a retracted position



NYLON THREAD LOCKING ELEMENT IS STANDARD ON ALL SIZES SHOWN ON THIS PAGE

To order ball plungers without a locking element, simply add an "X" to the end of the part number (ex. 52821X). Pricing is the same with or without locking element.

Part No.	End Force (lbs)		Thread A	B	C	D	E	F	Hex
	Initial	Final							
58501	1	4	1/4-20	.400	.125	.123	.750	.805	.125
58502	1	6	5/16-18	.530	.187	.154	.875	1.070	.125
58503	1	8	3/8-16	.750	.220	.185	1.000	1.260	.218
58504	1	10	1/2-13	.650	.250	.248	1.250	1.380	.250

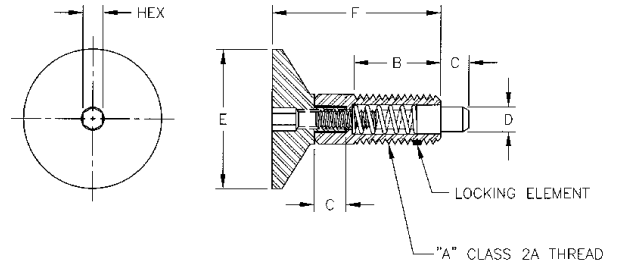

T-Handle Retractable Plunger: Locking

- Easy to grasp handle
- Locking plunger
- Withstands side loading
- Chamfered for easy alignment
- Plunger can be completely withdrawn into the body and locked into a retracted position

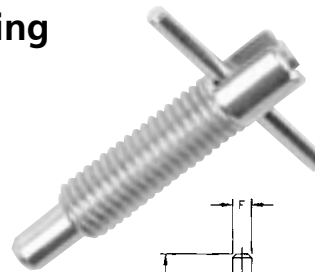

Steel Part No.*	Stainless Steel Part No.	End Force (lbs)		Thread A	B	C	D	E	F	G
		Initial	Final							
57701	57750	1.0	2.5	1/4-20	1.14	.250	.155	1.13	.13	.8
57702	57751	2.0	4.0	3/8-16	1.68	.375	.233	1.50	.13	1.2
57703	57752	2.0	5.0	1/2-13	2.00	.500	.312	2.00	.16	1.4
57704	57753	2.5	5.0	5/8-11	2.38	.625	.375	2.50	.19	1.7

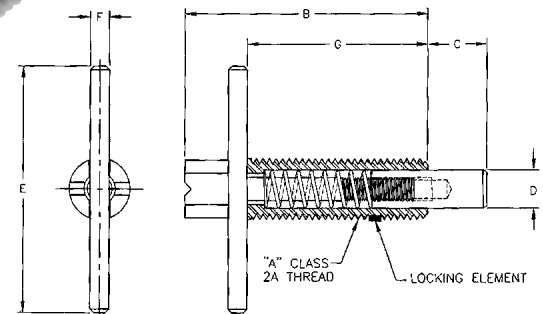

*Zinc Plated Clear Chromate Finish

Hand Retractable Spring Plunger Quick Release "Pull Ring" Steel & Stainless Steel: Locking

- Designed for applications where space is limited
- Plunger can be completely withdrawn into the body and locked into a retracted position
- Chamfered plunger for easy alignment

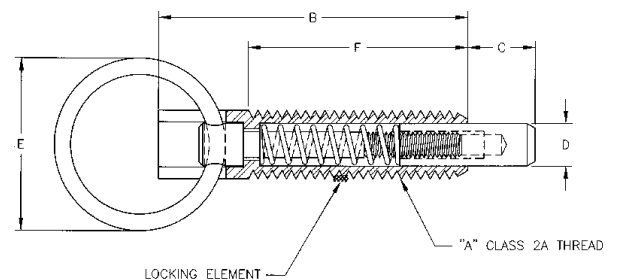

Steel* Black Part No.	Steel Clear Part No.	Stainless Steel Part No.	End Force (lbs)		Thread A	B	C	D	E	F	Weight (lbs/100pcs)
			Initial	Final							
54401	54414	54405	1.00	2.50	1/4-20	1.14	0.250	0.155	.62	.8	2
54402	54415	54406	2.00	4.00	3/8-16	1.68	0.375	0.233	.98	1.2	4
54403	54416	54407	2.50	5.00	1/2-13	2.00	0.500	0.312	1.26	1.4	9

*Black Oxide Finish **Zinc Plated Clear Chromate Finish

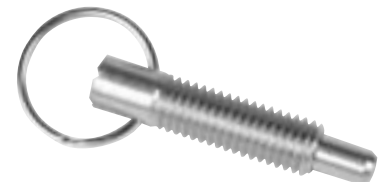

Stubby Hand Retractable Spring Plunger Quick Release "Pull Ring" Steel & Stainless Steel: Non-Locking

- Designed for applications where space is limited
- Chamfered plunger for easy alignment
- Withstands side loading

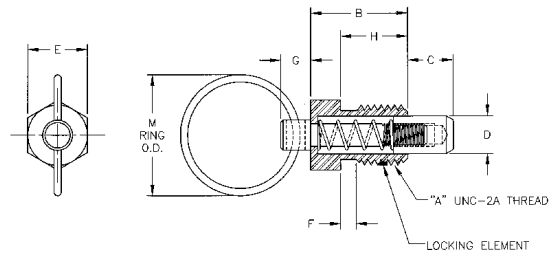

Steel** Part No.	Stainless Steel Part No.	End Force (lbs)		Thread A	B	C	D	Hex E	F	G	H	M
		Initial	Final									
54450	54455	.50	2.0	1/4-20	.44	.19	.16	.25	*	.18	.31	.62
54451	54456	.50	2.0	1/4-20	.44	.19	.16	.25	*	.18	.31	.75
54452	54457	.75	3.0	3/8-16	.63	.28	.25	.38	.13	.19	.44	.75
54453	54458	1.0	4.0	1/2-13	.81	.38	.31	.50	.13	.25	.56	1.0
54454	54459	1.25	5.0	5/8-11	1.0	.44	.38	.62	.13	.31	.69	1.0



*No thread relief **Zinc Plated Clear Chromate Finish

Lever Type Plunger: Locking

- Plunger can be completely withdrawn into the body and locked into a retracted position
- Chamfered plunger for easy alignment
- Built in drive wrench for rapid installation and alignment

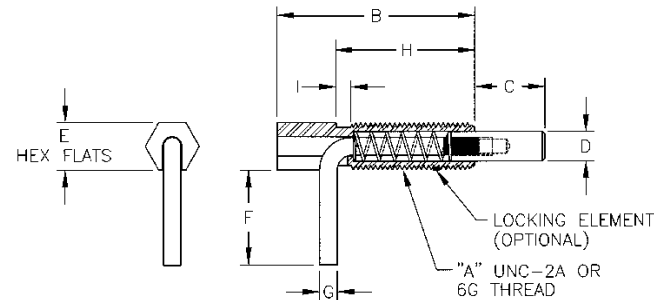

Steel* Part No.	Stainless Steel Part No.	End Force (lbs)		Thread A	B	C	D	Hex E	F	Dia G	H	I	Weight (lbs/100pcs)
		Initial	Final										
54305	54201	0.50	2.50	1/4-20	1.25	0.38	.16	.25	0.50	.09	0.80	*	2
54306	54202	0.75	3.75	3/8-16	2.00	0.56	.25	.38	0.75	.14	1.31	.13	5
54307	54203	1.00	5.00	1/2-13	2.11	0.75	.31	.50	0.93	.19	1.25	.15	10
54308	54204	1.00	5.00	5/8-11	3.05	1.00	.38	.62	1.00	.19	2.00	.18	15



*No thread relief in 1/4-20 thread size **Zinc Plated Clear Chromate Finish

METRIC

Steel** Part No.	Stainless Steel Part No.	End Force (lbs)		Thread A	B mm (in.)	C mm (in.)	D* mm (in.)	E mm (in.)	F mm (in.)	G mm (in.)	H mm (in.)	I mm (in.)
		Initial	Final									
64301	64201	.50	2.5	M6 x 1.0	32 (1.26)	10 (.39)	4 (.157)	6 (.236)	12.7 (.50)	2.3 (.09)	20 (.788)	*
64302	64202	.75	3.75	M10 x 1.5	51 (2)	14 (.55)	6 (.236)	10 (.39)	19 (.75)	3.5 (.14)	33 (1.3)	3.3 (1.3)
64303	64203	1.0	5.0	M12 x 1.75	54 (2.1)	19 (.75)	7 (2.75)	12 (.47)	25.4 (1.0)	4.8 (.19)	32 (1.26)	3.8 (1.5)

*No thread relief in M6 thread size **Zinc Plated Clear Chromate Finish

NYLON THREAD LOCKING ELEMENT IS STANDARD ON ALL SIZES
To order ball plungers without a locking element, simply add an "X" to the end of the part number (ex. 52821X). Pricing is the same with or without locking element.

Steel Hand Retractable Spring Plunger: Locking

- Fully retractable plunger
- Chamfered plunger for easy alignment
- Easy withdrawing and re-engagement

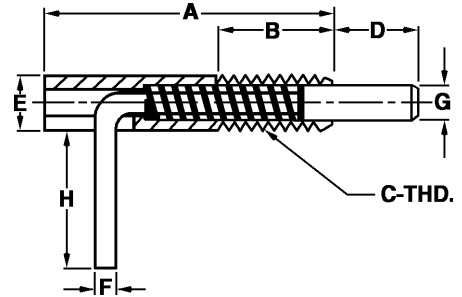
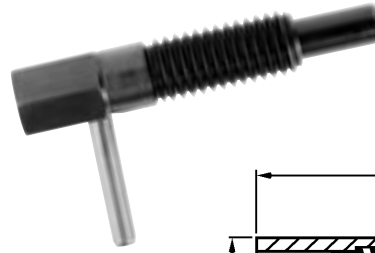

Steel* Part No.	End Force (lbs)		A	B	Thread C	D	Hex E	Dia F	+.000 -.001	
	Initial	Final							G	H
54301	.50	2.50	1.25	.50	1/4-20	.38	1/4	.101	.155	.50
54302	.75	3.75	2.00	1.00	3/8-16	.56	3/8	.134	.234	.74
54303	1.0	5.0	2.11	1.11	1/2-13	.75	1/2	.188	.313	1.00

*Black Oxide Finish

Lever Type Steel Plunger: Non-Locking

- Fully retractable plunger
- Chamfered plunger for easy alignment
- Easy withdrawing and re-engagement
- Zinc Plated Clear Chromate finish

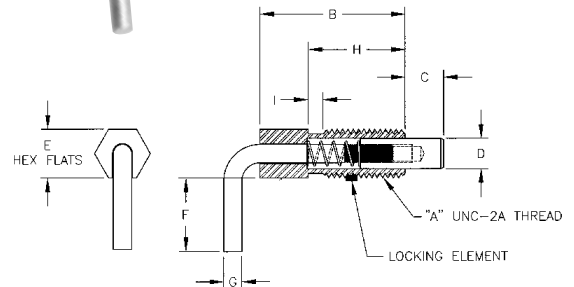
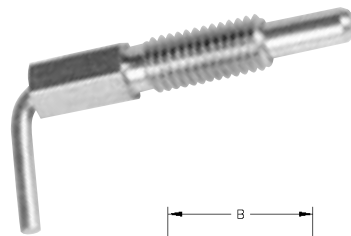

Part No.	End Force (lbs)		Thread A	B	C	D	Hex E	F	G	H	I
	Initial	Final									
54310	.50	2.50	1/4-20	1.25	.38	.16	.25	.50	.09	.80	*
54311	.75	3.75	3/8-16	2.00	.56	.25	.38	.75	.14	1.31	.13
54312	1.0	5.0	1/2-13	2.00	.75	.31	.50	1.0	.19	1.25	.15
54313	1.0	5.0	5/8-11	3.05	1.0	.38	.62	1.0	.19	2.0	.18

*No thread relief in 1/4-20 thread size

Lever Type Steel Stubby Plunger: Locking

- Designed for applications where space is limited
- Fully retractable plunger
- Chamfered plunger for easy alignment
- Zinc Plated Clear Chromate finish

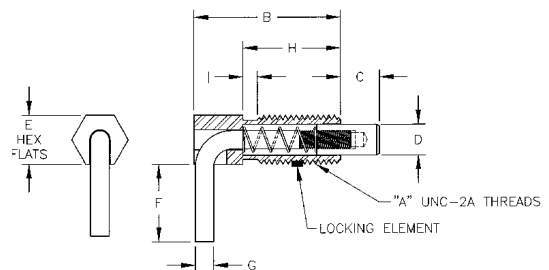

Part No.	End Force (lbs)		Thread A	B	C	Hex D	E	F	G	H	I
	Initial	Final									
54350	.12	.50	1/4-20	.75	.20	.16	.25	.40	.09	.50	*
54351	.25	1.25	3/8-16	1.13	.30	.25	.38	.56	.14	.75	.13
54352	.50	2.0	1/2-13	1.50	.40	.31	.50	.75	.19	1.0	.15
54353	.75	2.5	5/8-11	1.88	.50	.38	.62	.88	.19	1.25	.18

*No thread relief in 1/4-20 thread size

Lever Type Steel Stubby Plunger: Non-Locking

- Designed for applications where space is limited
- Fully retractable plunger
- Chamfered plunger for easy alignment
- Zinc Plated Clear Chromate finish

Part No.	End Force (lbs)		Thread A	B	C	D	Hex		G	H	I
	Initial	Final					E	F			
54360	.12	.50	1/4-20	.75	.20	.16	.25	.40	.09	.50	*
54361	.25	1.25	3/8-16	1.13	.30	.25	.38	.56	.14	.75	.13
54362	.50	2.0	1/2-13	1.50	.40	.31	.50	.75	.19	1.0	.15
54363	.75	2.5	5/8-11	1.88	.50	.38	.62	.88	.19	1.25	.18

*No thread relief in 1/4-20 thread size

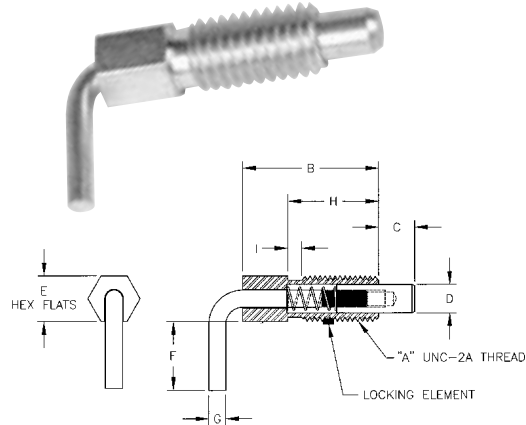

Spring Stops

- Material:
 - Body: Aluminum
 - Nose: Steel
- Part Nos. 53100 and 53103 have triangular bodies
- Part Nos. 53101, 53102, 53104 and 53105 have squared bodies as denoted by phantom line drawing
- **Two nose styles available:**
 - 53100-53102: Square Nose**
 - 53103-53105: Round Button Nose**
- Ideal for holding and securing parts while clamping

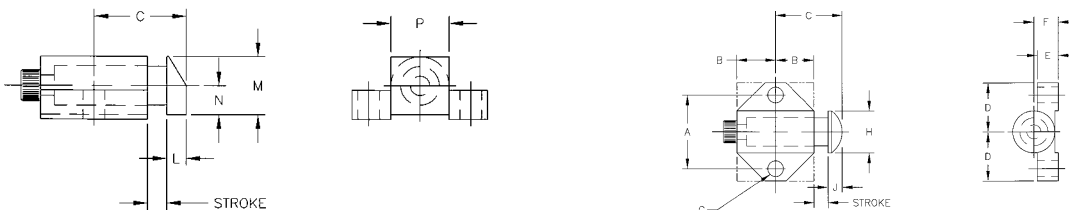

Part No.	End Force (lbs)		Stroke	A	B	C	D	E	F	G	H	J	L	M	N	P	Nose Style
	Initial	Final															
53100	5	15	1/8	21/32	11/32	19/32	7/16	3/16	7/32	0.128	–	–	1/8	3/8	3/16	3/8	Square
53101	2	26	3/16	1-1/8	1/2	15/16	3/4	1/4	5/16	0.193	–	–	1/4	5/8	5/16	5/8	Square
53102	16	48	1/4	1-1/2	11/16	1-1/4	1	1/8	17/32	0.257	–	–	5/16	3/4	3/8	3/4	Square
53103	5	15	1/8	21/32	11/32	19/32	7/16	3/16	7/32	0.128	3/8	1/8	–	–	–	–	Round Button
53104	2	26	3/16	1-1/8	1/2	7/8	3/4	1/4	5/16	0.193	9/16	3/16	–	–	–	–	Round Button
53105	16	48	1/4	1-1/2	11/16	1-11/64	1	1/8	17/32	0.257	13/16	1/4	–	–	–	–	Round Button



Installation Information for TE-CO Spring Loaded Devices

Most TE-CO Spring & Ball Plungers can be installed using a screwdriver, hex key wrench, or spring/ball plunger wrench (see page 28). Also, many Hand Retractable Spring Plungers can be installed without using any tools by simply using its knob to engage the threads. Because spring loaded devices have hollow bodies, the maximum installation torques they can withstand are significantly less than bolts or screws. The table below should be used as a guideline for installing spring loaded devices.

Unified Thread Size	Metric Thread Size	Max Installation Torque (inch pounds)
No. 4	M2.5 x 0.45	.60
No. 5	M3 x 0.5	1.25
No. 6	M3.5 x 0.6-6g	1.65
No. 8	M4 x 0.7-6g	2.15
No. 10	M5 x 0.8-6g	3.15
1/4	M6 x 1-6g	6.0
5/16	M8 x 1.25	11.0
3/8	M10 x 1.5	16.0
7/16	M11 x 1.5	22.0
1/2	M12 x 1.75	28.0
9/10	M14 x 2.0	36.0
5/8	M16 x 2.0	55.0
3/4	M20 x 2.5	70.0
7/8	M22 x 2.5	95.0
1	M24 x 3.0	130.0
1-1/8	M30 x 3.5	160.0
1-1/4	M33 x 3.5	190.0

Most TE-CO Spring Loaded Devices can be ordered with or without a nylon thread locking element (see each product group for details). The nylon-locking element forces the threads on the opposite side of a spring loaded device to compress against the mating threads of a tapped hole, providing the thread locking property. The nylon-locking element can cause installation problems when installing into softer metals or aluminum. This can be prevented by either using a larger tap drill when tapping, by ordering a spring plunger without a locking element, or by requesting a quote for a special plunger that will fit your needs.

When installing spring loaded devices with a nylon thread locking element pellet (thread sizes 1/4" and larger or M8 and larger), TE-CO recommends that the tapped installation hole be countersunk 90 degrees by 1/32 larger than major thread diameter to prevent damage to the locking element.

For more detailed information you may contact any of our knowledgeable TE-CO Customer Service Representatives at 800-543-4071.

Inch Tap Drill Sizes Table for Spring Plungers

Tap	Tap Drill	Decimal Equiv. of Tap Drill	Probable Hole Size	Percent Of Thread %
4-48	42	0.0935	0.0955	61
	3/32	0.0938	0.0958	60
	41	0.0960	0.0980	52
5-40	40	0.098	0.1003	76
	39	0.0995	0.1018	71
	38	0.1015	0.1038	65
	37	0.1040	0.1063	58
	37	0.1040	0.1063	78
6-32	36	0.1065	0.1091	71
	7/64	0.1094	0.1120	64
	35	0.1100	0.1126	63
	34	0.1110	0.1136	60
	33	0.1130	0.1156	55
6-40	34	0.1110	0.1136	75
	33	0.1130	0.1156	69
	32	0.1160	0.1186	60
8-32	29	0.1360	0.1389	62
	28	0.1405	0.1434	51
8-36	29	0.1360	0.1389	70
	28	0.1405	0.1434	57
	9/64	0.1406	0.1435	57
10-32	5/32	0.1563	0.1595	75
	22	0.1570	0.1602	73
	21	0.1590	0.1622	68
	20	0.1610	0.1642	64
	19	0.1660	0.1692	51
1/4-20	9	0.1960	0.1998	77
	8	0.1990	0.2028	73
	7	0.2010	0.2048	70
	13/64	0.2031	0.2069	66
	6	0.2040	0.2078	65
	5	0.2055	0.2093	63
	4	0.2090	0.2128	57
1/4-28	3	0.2130	0.2168	72
	7/32	0.2188	0.2226	59
	2	0.2210	0.2248	55
5/16-18	F	0.257	0.2608	72
	G	0.261	0.2651	66
	17/64	0.2656	0.2697	59
	H	0.2660	0.2701	59
3/8-16	5/16	0.3125	0.3169	72
	O	0.3160	0.3204	68
	P	0.3230	0.3274	59
1/2-13	27/64	0.4219	0.4266	73
	7/16	0.4375	0.4422	58
5/8-11	17/32	0.5313	0.5362	75
	36/64	0.5469	0.5518	62
3/4-10	41/64	0.6406	0.6456	80
	21/32	0.6563	0.6613	68
1-8	55/64	0.8594	0.8653	83
	7/8	0.8750	0.8809	73
	57/64	0.8906	0.8965	64
	29/32	0.9063	0.9122	54

Special Plunger Quotation Request

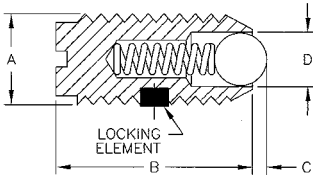

Ball Plunger

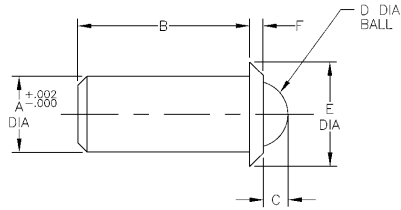

Press Fit Ball Plunger

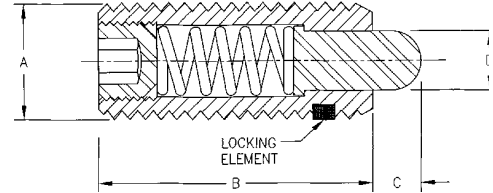

Spring Plunger

Dimension Information:

Thread "A" _____

Body Length "B" _____

Nose Length "C" _____

Nose Diameter "D" _____

Collar Diameter "E" _____ (Press Fit Ball Plunger Only)

Collar Height "F" _____ (Press Fit Ball Plunger Only)

Type Plunger: Ball _____ Press Fit Ball _____ Spring _____ Other _____

Application _____

Thread O.D. _____ (Class 2A)

Plunger Travel Distance: _____

Initial Force: _____ Final Force: _____

Locking Element: Yes _____ No _____ (Thread sizes 1/4" and smaller receive a nylon patch, all others receive a nylon pellet.)

Nose/Ball Material: _____ Nose/Ball Finish: _____

Body Material: _____ Body Finish: _____

Spring Material: _____

Applicable Environmental Conditions (Temperature Range, Chemical, Corrosives, Etc.)

Quantity: _____ Required Delivery: _____

Name _____

Company _____

Phone _____

Fax _____

Please photocopy this page as needed for quotation purposes